

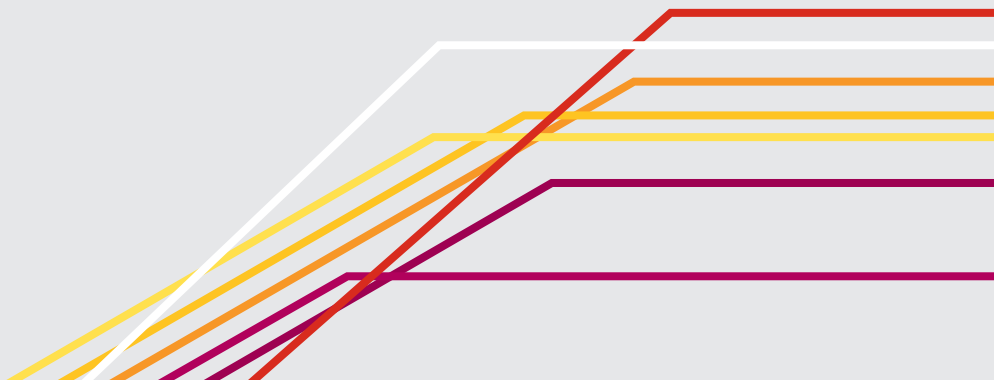

IBIZA ST

Owner's manual





Foreword

This Instruction Manual and its corresponding supplements should be read carefully to familiarise yourself with your vehicle.

Besides the regular care and maintenance of the vehicle, its correct handling will help preserve its value.

For safety reasons, always note the information concerning accessories, modifications and part replacements.

If selling the vehicle, give all of the on-board documentation to the new owner, as it should be kept with the vehicle.

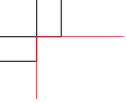

Table of Contents

Manual structure	5	LPG system*	58	Climatronic	140
		Digital instrument panel display	59	General notes	142
		Warning lamps	65	Driving	144
Content	6	Steering column controls*	78	Steering	144
		General information	78	Safety	145
		Audio Control	79	Ignition lock	145
Safety First	7	Audio + Telephone Control	80	Starting and stopping the engine	147
Safe driving	7	Opening and closing	82	Start-Stop function*	150
Brief introduction	7	Central locking	82	Manual gearbox	153
Proper sitting position for occupants	10	Keys	87	Automatic gearbox*	154
Pedal area	16	Radio frequency remote control*	88	Handbrake	161
Storing objects	16	Anti-theft alarm system*	90	Acoustic parking aid system*	163
Seat belts	19	Rear lid	93	Cruise speed* (Cruise control system)	164
Brief introduction	19	Windows	95		
Why wear seat belts?	21	Panoramic tilting sunroof*	98	Practical Tips	168
Seat belts	25	Lights and visibility	100	Intelligent technology	168
Belt tensioners*	28	Lights	100	Brakes	168
Airbag system	30	Interior lights	107	Anti-lock brake system and traction control ABS	169
Brief introduction	30	Visibility	108	Electronic Stability Control (ESC)*	170
Front airbags	34	Windscreen wipers	109	Driving and the environment	173
Side airbags	38	Rear view mirrors	112	Running-in	173
Deactivating airbags*	41	Seats and storage compartments	115	Exhaust gas purification system	174
Child safety	43	The importance of correct seat adjustment	115	Economical and environmentally friendly driving	176
Brief introduction	43	Head restraints	116	Driving abroad	178
Child seats	45	Front seats	118	Trailer towing	178
Securing child seats	48	Rear seats	120	Vehicle maintenance and cleaning	181
		Storage compartment	122	General notes	181
Operating Instructions	55	Ashtrays, cigarette lighter and power socket	125	Care of the vehicle exterior	182
		First-aid kit, warning triangle, fire extinguisher	128	Vehicle interior maintenance	187
Cockpit	55	Luggage compartment	129		
Overview	55	Roof rack*	132		
Instruments	57	Air conditioning	134		
		Heating	134		
		Air conditioning*	137		

Accessories, replacement of parts and modifications	190	Jump-starting	248
Accessories and spare parts	190	Towing and tow-starting	252
Technical modifications	190		
Roof aerial*	191	Technical Specifications	255
Mobile telephones and two-way radios	191	Description of specifications	255
Fitting a towing bracket*	192	Important information	255
Checking and refilling levels	194	Information on fuel consumption	257
Refuelling	194	Towing a trailer	257
LPG system*	196	Wheels	258
Petrol	199	Technical specifications	259
Diesel	199	Checking fluid levels	259
Working in the engine compartment	200	Petrol engine 1.2 51 kW (70 PS)	260
Engine oil	203	Petrol engine 1.2 TSI 63 kW (85 PS)	261
Coolant	207	Petrol engine 1.4 63 kW (85 PS)	262
Washer fluid and windscreen wiper blades	209	Petrol engine 1.2 TSI 77 kW (105 PS)	263
Brake fluid	213	Petrol engine 1.2 TSI 77 kW (105 PS) Start-Stop	264
Vehicle battery	214	Petrol engine 1.4 TSI 110 kW (150 PS) automatic	265
Wheels	216	Diesel engine 1.2 TDI CR 55 kW (75 PS) DPF	266
If and when	223	Start-Stop Ecomotive	266
Vehicle tools, spare wheel	223	Diesel engine 1.2 TDI CR 55 kW (75 PS) DPF	267
Wheel change	224	Diesel engine 1.6 TDI CR 66 kW (90 PS) DPF	268
Tyre repair kit (Tyre-Mobility-System)*	229	Diesel engine 1.6 TDI CR 77 kW (105 PS) with/without DPF	269
Fuses	231	Dimensions and capacities	270
Bulb change	234		
Single headlight bulb change	236	Index	271
Double headlight bulb change	238		
Changing the bulbs of AFS headlights	242		
Changing the fog light bulbs	243		
Changing the rear lights (on the wing)	244		
Changing the rear lights (on the rear lid)	245		
Side turn signal bulbs	246		
Number plate light	247		
Interior light and front reading lights	247		
Additional brake lights*	248		
Luggage compartment light	248		

Manual structure

What you should know before reading this manual

This manual contains a description of the **equipment** supplied with the vehicle at the time of press. Some of the equipment hereunder described will not be available until a later date, or is only available in certain markets.

As this is a general manual for the IBIZA ST, some of the equipment and functions described in this manual are not included in all types or versions of the model. These may vary or be modified depending on technical and market requirements, which can in no way be interpreted as deceptive advertising.

The **illustrations** are intended as a general guide and may vary from the equipment fitted in your vehicle in some details.

The **direction indications** (left, right, front, rear) appearing in this manual refer to the normal forward working direction of the vehicle except when otherwise indicated.

The equipment marked with an asterisk** is fitted as standard only in certain versions, and is only supplied as optional extras for some versions, or are only offered in certain countries.

- Ⓢ All registered marks are indicated with Ⓢ. Although the copyright symbol does not appear, it is a copyrighted mark.
- ▶ The section is continued on the following page.
- Marks the **end of a section**.



WARNING

Texts preceded by this symbol contain information on safety. They warn you about possible dangers of accident or injury.



CAUTION

Texts with this symbol draw your attention to potential sources of damage to your vehicle.



For the sake of the environment

Texts preceded by this symbol contain relevant information concerning environmental protection.



Note

Texts preceded by this symbol contain additional information. ■

Content

This manual is structured to provide the information you need in an organised way. The content of this Manual is divided into **sections** which belong to **chapters** (e.g. "Air conditioning"). The entire manual is divided into five large parts which are:

1. Safety First

Information about the vehicle equipment relating to passive safety such as seat belts, airbags, seats, etc.

2. Operating instructions

Information about the distribution of controls in the driver position of your vehicle, about the seat adjustment possibilities, about how to create a suitable climate in the vehicle interior, etc.

3. Practical Tips

Advice relating to the driving, caring and maintenance of your vehicle and certain problems you can solve yourself.

4. Technical specifications

Figures, values and the dimensions of your vehicle.

5. Alphabetic index

At the end of this manual there is a detailed alphabetical index, this will help you to quickly find the information you require. ■

Safety First

Safe driving

Brief introduction

Dear SEAT Driver

Safety first!

This chapter contains important information, tips, suggestions and warnings that you should read and consider for both your own safety and for your passengers' safety.



WARNING

- This manual contains important information about the operation of the vehicle, both for the driver and the passengers. The other sections of the on-board documentation also contain further information that you should be aware of for your own safety and for the safety of your passengers.
- Ensure that the on-board documentation is kept in the vehicle at all times. This is especially important when lending or selling the vehicle to another person.

Safety equipment

The safety equipment is a part of the occupant protection system and can reduce the risk of injury in the event of an accident.

Never put your safety or the safety of your passengers in danger. In the event of an accident, the safety equipment may reduce the risk of injury. The following list includes most of the safety equipment in your SEAT:

- Three-point seat belts
- Belt tension limiter for the front and rear side seats
- Belt tensioners for the front seats
- Front airbags
- Side airbags in the front seat backrests, with chest and head protection
- ISOFIX anchor points for ISOFIX rear child seat system
- Height-adjustable front head restraints
- Rear-centre head restraints with in-use position and non-use position
- Adjustable steering column

The safety equipment mentioned above works together to provide you and your passengers with the best possible protection in the event of an accident. However, these safety systems can only be effective if you and your passengers are sitting in a correct position and use this equipment properly.

Therefore, information is provided about why this equipment is so important, how it protects you, what you have to consider when using it and how ►

you and your passengers can achieve the greatest possible benefit from the safety equipment fitted. This manual includes important warnings that you and your passengers should note in order to reduce the risk of injury.

Safety is everyone's business!

Before setting off

The driver is always responsible for the safety of the passengers and the safe operation of the vehicle.

For your own safety and the safety of your passengers, always note the following points before every trip:

- Make sure that the vehicle's lights and turn signals are working properly.
- Check tyre pressure.
- Ensure that all windows provide a clear and good view of the surroundings.
- Secure all baggage. ⇒ page 16.
- Make sure that no objects can interfere with the pedals.
- Adjust front seat, head restraint and rear vision mirrors properly according to your size.
- Ensure that the passenger in the central rear seat always has the head restraint in the correct position for use.
- Instruct passengers to adjust the head restraints according to their height.

- Protect children with appropriate child seats and properly applied seat belts ⇒ page 43.
- Assume the correct sitting position. Instruct your passengers also to assume a proper sitting position. ⇒ page 10.
- Fasten your seat belt securely. Instruct your passengers also to fasten their seat belts properly. ⇒ page 19.

What affects driving safety?

Driving safety is largely determined by your driving style and the personal behaviour of all vehicle occupants.

As a driver, you are responsible for yourself and your passengers. When your concentration or driving safety is affected by any circumstance, you endanger yourself as well as others on the road ⇒ , for this reason:

- Always pay attention to traffic and do not get distracted by passengers or telephone calls.
- Never drive when your driving ability is impaired (e.g. by medication, alcohol, drugs).
- Observe traffic laws and speed limits.
- Always reduce your speed as appropriate for road, traffic and weather conditions.
- When travelling long distances, take breaks regularly - at least every two hours.
- If possible, avoid driving when you are tired or stressed. ▶

**WARNING**

When driving safety is impaired during a trip, the risk of injury and accidents increases.

Proper sitting position for occupants

Correct sitting position for driver

The correct sitting position for the driver is important for safe and relaxed driving.

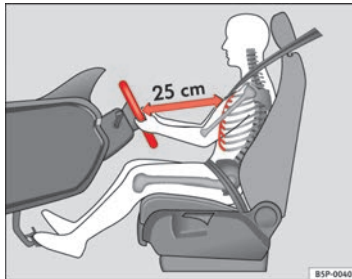

Fig. 1 The correct distance between driver and steering wheel

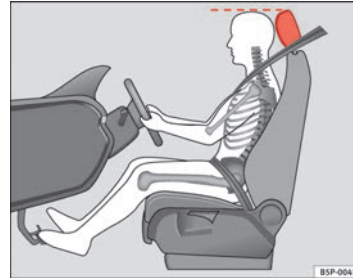



Fig. 2 Correct head restraint position for driver

For your own safety and to reduce the risk of injury in the event of an accident, we recommend the following adjustments for the driver:

- Adjust the steering wheel so that there is a distance of at least 25 cm between the steering wheel and the centre of your chest ⇒ Fig. 1.
- Move the driver seat forwards or backwards so that you are able to press the accelerator, brake and clutch pedals to the floor with your knees still slightly angled ⇒ .
- Ensure that you can reach the highest point of the steering wheel.
- Adjust the head restraint so that its upper edge is at the same level as the top of your head, or as close as possible to the same level as the top of your head ⇒ Fig. 2.
- Move the seat backrest to an upright position so that your back rests completely against it. ▶

- Fasten your seat belt securely ⇒ page 19.
- Keep both feet in the footwell so that you have the vehicle under control at all times.

Adjustment of the driver seat ⇒ page 115.

WARNING

- An incorrect sitting position of the driver can lead to severe injuries.
- Adjust the driver seat so that there is at least 25 cm distance between the centre of the chest and the centre of the steering wheel ⇒ Fig. 1. If distance is less than 25 cm, the airbag system may not protect you properly.
- If your physical constitution prevents you from maintaining the minimum distance of 25 cm, contact a specialised workshop. The workshop will help you decide if special specific modifications are necessary.
- When driving, always hold the steering wheel with both hands on the outside of the ring at the 9 o'clock and 3 o'clock positions. This reduces the risk of injury when the driver airbag is triggered.
- Never hold the steering wheel at the 12 o'clock position, or in any other manner (e.g. in the centre of the steering wheel). In such cases, if the airbag is triggered, you may sustain injuries to the arms, hands and head.
- To reduce the risk of injury to the driver during sudden braking manoeuvres or an accident, never drive with the backrest tilted far back! The airbag system and seat belts can only provide optimal protection when the backrest is in an upright position and the driver is wearing his or her seat belt correctly. The further the seat backrests are tilted to the rear, the greater the risk of injury due to incorrect positioning of the belt web or to the incorrect sitting position!
- Adjust the head restraint properly to achieve optimal protection. ■

Correct sitting position for front passenger

The front passenger must sit at least 25 cm away from the dash panel so that the airbag can provide the greatest possible protection in the event that it is triggered.

For your own safety and to reduce the risk of injury in the event of an accident, we recommend the following adjustments for the front passenger:

- Move the front passenger seat back as far as possible ⇒ .
- Move the seat backrest to an upright position so that your back rests completely against it.
- Adjust the head restraint so that its upper edge is at the same level as the top of your head, or as close as possible to the same level as the top of your head ⇒ page 13.
- Always keep both feet in the footwell in front of the front passenger seat.
- Fasten your seat belt securely ⇒ page 19.

It is possible to deactivate the front passenger airbag in **exceptional circumstances** ⇒ page 41.

Adjusting the front passenger seat ⇒ page 118. ▶

**WARNING**

- An incorrect sitting position of the front passenger can lead to severe injuries.
- Adjust the front passenger seat so that there is at least 25 cm between your chest and the dash panel. If distance is less than 25 cm, the airbag system may not protect you properly.
- If your physical constitution prevents you from maintaining the minimum distance of 25 cm, contact a specialised workshop. The workshop will help you decide if special specific modifications are necessary.
- Always keep your feet in the footwell when the vehicle is moving; never rest them on the dash panel, out the window or on the seat. An incorrect sitting position exposes you to an increased risk of injury in case of a sudden braking or an accident. If the airbag is triggered, you could sustain severe injuries due to an incorrect sitting position.
- To reduce the risk of injury to the front passenger in events such as sudden braking manoeuvres or an accident, never travel with the backrest tilted far back! The airbag system and seat belts can only provide optimal protection when the backrest is in an upright position and the front passenger is wearing his or her seat belt properly. The further the seat backrests are tilted to the rear, the greater the risk of injury due to incorrect positioning of the belt web or to the incorrect sitting position!
- Adjust the head restraint correctly in order to achieve maximum protection.

Correct sitting position for passengers in the rear seats

Passengers in the rear seats must sit up straight, keep their feet on the footwells, have the rear central head restraint positioned for use and wear their seat belts properly.

To reduce the risk of injury in the event of a sudden braking manoeuvre or an accident, passengers on the rear seat bench must consider the following:

- Adjust the head restraint to the correct position ⇒ page 13.
- Always keep both feet in the footwell in front of the rear seat.
- Fasten your seat belt securely ⇒ page 19.
- Use an appropriate child restraint system when you take children in the vehicle ⇒ page 43.

**WARNING**

- If the passengers in the rear seats are not sitting properly, they could sustain severe injuries.
- Adjust the head restraint correctly in order to achieve maximum protection.
- Seat belts can only provide optimal protection when seat backrests are in an upright position and the vehicle occupants are wearing their seat belts correctly. If passengers in the rear seats are not sitting in an upright position, the risk of injury due to incorrect positioning of the seat belt increases.

Correct adjustment of head restraints

Properly adjusted head restraints are an important part of passenger protection and can reduce the risk of injuries in most accident situations.

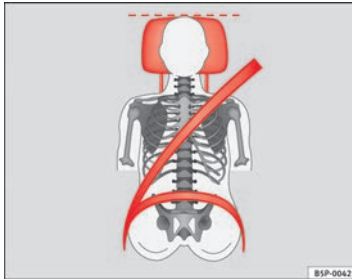

Fig. 3 Correctly adjusted head restraint viewed from the front

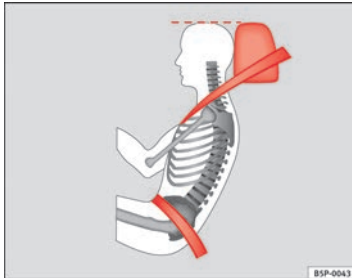

Fig. 4 Correctly adjusted head restraint viewed from the side

Adjust the head restraint correctly in order to achieve maximum protection.

- Adjust the head restraint so that its upper edge is at the same level as the top of your head or as close as possible to the same level as the top of your head and, at the very least, at eye level
⇒ Fig. 3 and ⇒ Fig. 4.

Adjusting the head restraints ⇒ page 116

WARNING

- Travelling with the head restraints removed or improperly adjusted increases the risk of severe injuries.
- Incorrectly adjusted head restraints could result in death in the event of a collision or accident.
- Incorrectly adjusted head restraints also increase the risk of injury during sudden or unexpected driving or braking manoeuvres.
- The head restraints must always be adjusted according to the height of the passenger.

Rear head restraints

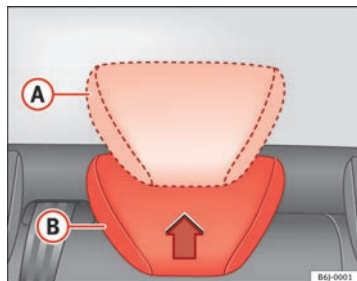

Fig. 5 Adjusting the rear head restraints

The rear head restraints have 2 positions:

- Raised position or position for use (A) ⇒ Fig. 5. In this position, the head restraint is used normally, protecting the occupant of the rear seats, along with the rear seat belts.
- Rest position, not in use (B) ⇒ Fig. 5. This position improves the driver's rear visibility.

To fit the head restraint in position for use (A), pull on the edges with both hands in the direction of the arrow. To place it in rest position (B), lower the head restraint.

WARNING

Whenever a passenger is seated on the rear central seat, the head restraint should be placed in the position for use (A).



Note

Note the instructions on the head restraints adjustment. ■

Examples of incorrect sitting positions

An incorrect sitting position can lead to severe injuries to vehicle occupants.

Seat belts can provide optimal protection only when the belt webs are properly positioned. Incorrect sitting positions substantially reduce the protective function of seat belts and increase the risk of injury due to incorrect seat belt position. As the driver, you are responsible for all passengers, especially children.

- Never allow anyone to assume an incorrect sitting position in the vehicle while travelling ⇒ .

The following list contains examples of sitting positions that could be dangerous for all vehicle occupants. The list is not complete, but we would like to make you aware of this issue.

Therefore, whenever the vehicle is in motion:

- Never stand in the vehicle.
- Never stand on the seats.
- Never kneel on the seats.
- Never tilt your seat backrest far to the rear.
- Never lean against the dash panel.
- Never lie on the rear bench.
- Never sit on the front edge of a seat.
- Never sit sideways.
- Never lean out of a window. ▶

- Never put your feet out of a window.
- Never put your feet on the dash panel.
- Never put your feet on the surface of a seat.
- Do not allow anyone to travel in the footwell.
- Never travel without wearing the seat belt.
- Do not allow anyone to travel in the luggage compartment.

**WARNING**

- Any incorrect sitting position increases the risk of severe injuries.
- Sitting in an incorrect position exposes the vehicle occupants to severe injuries if airbags are triggered, by striking a vehicle occupant who has assumed an incorrect sitting position.
- Before the vehicle moves, assume the proper sitting position and maintain it throughout the trip. Before every trip, instruct your passengers to sit properly and to stay in this position during the trip ⇒ page 10, Proper sitting position for occupants.

Pedal area

Pedals

The operation of all pedals must never be impaired by objects or floor mats.

- Ensure that you can always press the accelerator, brake and clutch pedals unimpaired to the floor.
- Ensure that the pedals can return unimpaired to their initial positions.

Use only floor mats which leave the pedal area free and can be securely fastened on the footwell.

If a brake circuit fails, the brake pedal must be pressed down thoroughly in order to stop the vehicle.

Wearing suitable shoes

Always wear shoes which support your feet properly and give you a good feeling for the pedals.

WARNING

- Restricting pedal operation can lead to critical situations while driving.
- **Never place objects on the driver footwell. An object could move into the pedal area and impair pedal operation. In the event of a sudden driving or braking manoeuvre, you will not be able to operate the brake, clutch or accelerator pedal. Risk of accident!**

Floor mats on the driver side

Only floor mats may be used which can be securely fastened in the footwell and do not impair operation of the pedals.

- Ensure that the floor mats are securely fastened during the trip and do not obstruct the pedals → .

Only use floor mats which leave the pedals clear and which are secured to prevent them from slipping. You can obtain suitable floor mats from a specialised dealership.

WARNING

- **If the pedals are obstructed, an accident may occur. Risk of serious injuries.**
- **Ensure that the floor mats are always securely attached.**
- **Never lay or fit floor mats or other floor coverings over the original floor mats. This would reduce the pedal area and could obstruct the pedals. Risk of accident.**

Storing objects

Loading the luggage compartment

All luggage and other loose objects must be safely secured in the luggage compartment.

Unsecured objects which shift back and forth could affect safety or driving characteristics of the vehicle by shifting the centre of gravity. ▶

- Distribute the load evenly in the luggage compartment.
- Place heavy objects as far forward as possible in the luggage compartment.
- Place the heavy objects first.

WARNING

- **Loose luggage and other objects in the luggage compartment could cause serious injuries.**
- **Always put objects in the luggage compartment.**
- **During sudden manoeuvres or accidents, loose objects can be thrown forward, injuring vehicle occupants or even third parties. This increased risk of injury will be further increased if a loose object is struck by an inflating airbag. If this happens, objects can be transformed into “missiles”. Risk of fatal injury.**
- **Please note that the centre of gravity may shift when transporting heavy objects; this may affect vehicle handling and lead to an accident. Therefore, it is essential to adjust your speed and driving style accordingly, to avoid accidents.**
- **Never exceed the allowed axle weights or allowed maximum weight. If the allowed axle load or the allowed total weight is exceeded, the driving characteristics of the vehicle may change, leading to accidents, injuries and damage to the vehicle.**
- **Never leave your vehicle unattended, especially when the rear lid is open. Children could climb into the luggage compartment, closing the door behind them; they will be trapped and run the risk of death.**
- **Never allow children to play in or around the vehicle. Close and lock all the doors and rear lid when you leave the vehicle. Before you lock the vehicle, make sure that there are no adults or children in the vehicle.**
- **Never transport passengers in the luggage compartment. All vehicle occupants must have their seat belt fastened ⇒ page 19.**



Note

- Air circulation in the vehicle helps reduce fogging of the windows. Used air escapes through ventilation slits in the side trim of the luggage compartment. Ensure that the ventilation slits are never covered. ■

Fastening rings

There can be four fastening rings in the luggage compartment for fastening luggage and other objects.

- Always use suitable and undamaged straps to secure luggage and other objects to the fastening rings ⇒  in Loading the luggage compartment on page 17.
- Pull up the fastening rings to attach the straps.

During a collision or an accident, even small and light objects can build up so much energy that they can cause very severe injuries. The amount of kinetic energy depends on the speed of the vehicle and the weight of the object. The most significant factor, however, is the speed of the vehicle.

Example: An object weighing 4.5 kg is lying unsecured in the vehicle. During a frontal collision at a speed of 50 km/h (30 mph), this object generates a force corresponding to 20 times its weight. That means that the effective weight of the object increases to about 90 kg. You can imagine the severity of the injuries which might be sustained if this object strikes an occupant as it flies through the interior of the vehicle. This increased risk of injury will be further increased if a loose object is struck by an inflating airbag. ▶

**WARNING**

- If pieces of luggage or other objects are secured to the fastening rings with inappropriate or damaged retaining cords, injuries could be sustained in the event of braking manoeuvres or accidents.
- To prevent pieces of luggage or other objects from flying forward, always use appropriate retaining cords which are secured to the fastening rings.
- Never secure a child seat on the fastening rings. ■

Seat belts

Brief introduction

Before driving: remember your seat belt!

Wearing a seat belt properly can save your life!

In this section you will learn the importance of wearing seat belts, how they work and how to properly fasten, adjust and wear them.

- Read and consider all the information as well as the warnings in this chapter.

WARNING

- Before inserting the central rear seat belt into its catch, make sure that the backrest is properly engaged in position by pulling on the belt.
- If seat belts are worn incorrectly or not at all, the risk of severe injuries increases.
- Properly worn seat belts can reduce severe injuries in case of sudden braking manoeuvres or accidents. For safety reasons, you and all other vehicle occupants must always wear the seat belts properly while the vehicle is moving.
- Pregnant women or people with physical disabilities must also use seat belts. Like all other vehicle occupants, these people can also sustain severe injuries if they are not wearing their seat belts properly.

Number of seats

Your vehicle has **five** seats, two in the front and three in the rear. Each seat is equipped with a three-point seat belt.

In some versions, your vehicle is approved **only** for four seats. Two front seats and two rear seats.

WARNING

- Never transport more than the permitted amount of people in your vehicle.
- Every vehicle occupant must properly fasten and wear the seat belt belonging to his or her seat. Children must be protected with an appropriate child restraint system.

Seat belt warning lamp*

The control lamp acts as a reminder to the driver to fasten the seat belt.

Before starting the vehicle:

- Fasten your seat belt securely.
- Instruct your passengers to fasten their seat belts properly before driving off.
- Protect children by using a child seat according to the child's height and weight.

The control lamp  in the instrument panel lights up¹⁾ if the driver or passenger seat belt is not fastened¹⁾ when the ignition is switched on. Moreover, an audible warning¹⁾ is heard on exceeding 25 km/h (15 mph). This acoustic signal stops when the seat belt is fastened.

The warning lamp*  is switched off if the driver seat belt is fastened while the ignition is switched on. ■

¹⁾ Depending on the model version

Why wear seat belts?

Physical principles of frontal collisions

In the event of a frontal collision, a large amount of kinetic energy must be absorbed.

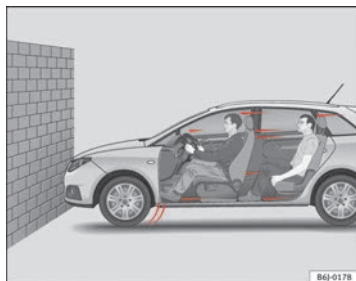

Fig. 6 Vehicle about to hit a wall: the occupants are not wearing seat belts

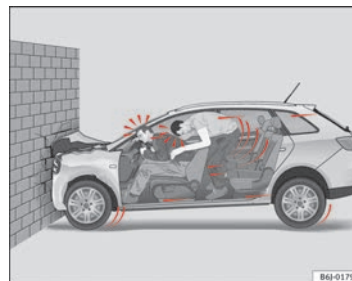

Fig. 7 The vehicle hits the wall: the occupants are not wearing seat belts

It is easy to explain how the laws of physics work in the case of a head-on collision: When a vehicle starts moving \Rightarrow Fig. 6, a certain amount of energy known as kinetic energy is produced in the vehicle and its occupants.

The amount of kinetic energy depends on the speed of the vehicle and the weight of the vehicle and its passengers. The higher the speed and the greater the weight, the more energy there is to be released in an accident.

The most significant factor, however, is the speed of the vehicle. If the speed doubles from 25 km/h (15 mph) to 50 km/h (30 mph), for example, the kinetic energy is multiplied by four.

Because the vehicle occupants in our example are not restrained by seat belts, all of the occupants' kinetic energy has to be absorbed at the point of impact \Rightarrow Fig. 7.

Even at speeds of 30 km/h (20 mph) to 50 km/h (30 mph), the forces acting on bodies in a collision can easily exceed one tonne (1000 kg). At greater speed these forces are even higher. ▶

Vehicle occupants not wearing seat belts are not “attached” to the vehicle. In a head-on collision, they will move forward at the same speed their vehicle was travelling just before the impact. This example applies not only to head-on collisions, but to all accidents and collisions. ■

The danger of not using the seat belt

The general belief that the passengers can protect themselves with their hands in a minor collision is false.



Fig. 8 A driver not wearing a seat belt is thrown forward violently



Fig. 9 The unbelted passenger in the rear seat is thrown forward violently, hitting the driver wearing a seat belt

Even at low speeds the forces acting on the body in a collision are so great that it is not possible to brace oneself with one's hands. In a frontal collision, unbelted vehicle occupants are thrown forward and will make violent contact with the steering wheel, dash panel, windscreen or whatever else is in the way → Fig. 8.

The airbag system is not a substitute for seat belts. When triggered, airbags provide only additional protection. All occupants (including the driver) must wear seat belts properly at all times during the trip. This will reduce the risk of severe injuries in the event of an accident – regardless of whether an airbag is fitted for the seat or not.

Note that airbags can be triggered only once. To achieve the best possible protection, the seat belt must always be worn properly so that you will be protected in accidents in which no airbag is deployed.

It is also important for the rear passengers to wear seat belts properly, as they could otherwise be thrown forward violently through the vehicle interior in an accident. Passengers in the rear seats who do not use seat belts endanger not only themselves but also the front occupants → Fig. 9. ■

Seat belt protection

Passengers not wearing seat belts risk severe injuries in the event of an accident.



Fig. 10 A driver wearing the seat belt properly is secured by the belt in sharp braking

Properly worn seat belts hold the vehicle occupants in the correct sitting positions and substantially reduce the kinetic energy in the event of an accident. Seat belts also help to prevent uncontrolled movements that could lead to severe injuries. In addition, properly worn seat belts reduce the danger of being thrown from the vehicle.

Vehicle occupants wearing their seat belts correctly benefit greatly from the ability of the belts to absorb kinetic energy. The front part of your vehicle and other passive safety features (such as the airbag system) are also designed to absorb the kinetic energy released in a collision. Taken together, all these features reduce the releasing kinetic energy and consequently, the risk of injury.

Our examples describe frontal collisions. Of course, properly worn seat belts substantially reduce the risk of injury in all other types of accidents. This is why it is so important to fasten seat belts before every trip, even when "just driving around the corner".

Ensure that your passengers wear their seat belts as well. Accident statistics have shown that wearing seat belts is an effective means of substantially reducing the risk of injury and improving the chances of survival in a serious accident. Furthermore, properly worn seat belts improve the protection provided by airbags in the event of an accident. For this reason, wearing a seat belt is required by law in most countries.

Although your vehicle is equipped with airbags, the seat belts must be fastened and worn. The front airbags, for example, are only triggered in some frontal accidents. The front airbags will not be triggered during minor frontal collisions, minor side collisions, rear collisions, overturns or accidents in which the airbag trigger threshold value in the control unit is not exceeded.

Therefore, you should always wear your seat belt and ensure that all vehicle occupants have fastened their seat belts properly before you drive off! ■

Safety instructions on using seat belts

If seat belts are used correctly, they can considerably reduce the risk of injury in an accident.

- Always wear the seat belt as described in this section.
- Ensure that the seat belts can be fastened at all times and are not damaged. ▶

**WARNING**

- If the seat belts are worn incorrectly or not at all, the risk of severe injuries increases. The optimal protection from seat belts can be achieved only if you use them properly.
- Fasten your seat belt before every trip - even when driving in town. The other vehicle occupants must also wear the seat belts at all times, otherwise they run the risk of being injured.
- The seat belt cannot offer its full protection if the seat belt is not positioned correctly.
- Never allow two passengers (even children) to share the same seat belt.
- Always keep both feet in the footwell in front of your seat as long as the vehicle is in motion.
- Never unbuckle a seat belt while the vehicle is in motion. Risk of fatal injury.
- The seat belt must never be twisted while it is being worn.
- The seat belt should never lie on hard or fragile objects (such as glasses or pens, etc.) because this can cause injuries.
- Do not allow the seat belt to be damaged or jammed, or to rub on any sharp edges.
- Never wear the seat belt under the arm or in any other incorrect position.
- Loose, bulky clothing (such as an overcoat over a jacket) impairs the proper fit and function of the seat belts, reducing their capacity to protect.
- The slot in the seat belt buckle must not be blocked with paper or other objects, as this can prevent the latch plate from engaging securely.
- Never use seat belt clips, fastening rings or similar instruments to alter the position of the belt webbing.

**WARNING (Continued)**

- Frayed or torn seat belts or damage to the connections, belt retractors or parts of the buckle could cause severe injuries in the event of an accident. Therefore, you must check the condition of all seat belts at regular intervals.
- Seat belts which have been worn in an accident and stretched must be replaced by a specialised workshop. Renewal may be necessary even if there is no apparent damage. The belt anchorage should also be checked.
- Do not attempt to repair a damaged seat belt yourself. The seat belts must not be removed or modified in any way.
- The belts must be kept clean, otherwise the retractors may not work properly.

Seat belts

Seat belt adjustment

The seat belts for the front and rear occupants are locked in to position by a latch.

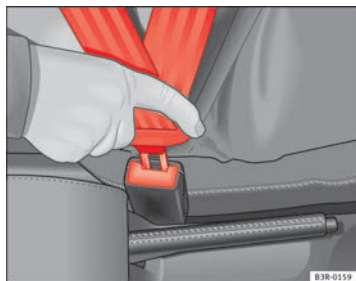

Fig. 11 Belt buckle and latch plate of seat belt

The seat belt cannot offer its full protection if the seat belt is not positioned correctly.

- Adjust the seat and head restraint correctly.
- To fasten the belt, take hold of the latch plate and pull it slowly across your chest and lap.
- Insert the latch plate into the buckle for the appropriate seat and push it down until it is securely locked with an audible click ⇒ Fig. 11.

- Pull the belt to ensure that the latch plate is securely engaged in the buckle.

The seat belts are equipped with an automatic retractor on the shoulder strap. Full freedom of movement is permitted when the shoulder belt is pulled slowly. However, during sudden braking, during travel in steep areas or bends and during acceleration, the automatic retractor on the shoulder belt is locked.

The automatic belt retractors on the front seats are fitted with seat belt tensioners ⇒ page 28.

 WARNING	
<ul style="list-style-type: none"> • An incorrectly worn seat belt can cause severe injuries in the event of an accident. • The seat belts offer best protection only when the backrests are in an upright position and the seat belts have been fastened properly. • Never put the latch plate in the buckle of another seat. If you do this, the seat belt will not protect you properly and the risk of injury is increased. • If a vehicle occupant is incorrectly belted in, the seat belt cannot protect him or her properly. An incorrectly positioned seat belt can cause extremely severe injuries. 	■

Seat belt position

Seat belts offer their maximum protection only when they are properly positioned.

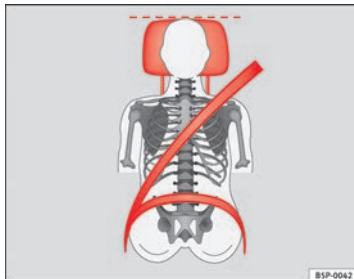

Fig. 12 Correct seat belt and head restraint positions, viewed from front

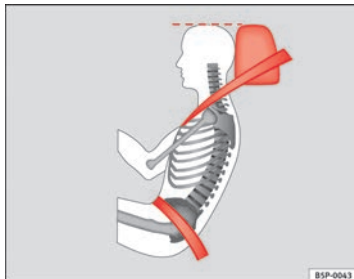

Fig. 13 Correct seat belt and head restraint positions, viewed from side



WARNING

- An incorrectly worn seat belt can cause severe injuries in the event of an accident.
- The shoulder belt must be positioned around the middle of the shoulder. The seat belt must lie flat and snugly on the torso ⇒ Fig. 12.
- The lap part of the seat belt must lie across the pelvis, never across the stomach. The seat belt must lie flat and snugly on the pelvis ⇒ Fig. 13. Pull the belt tight if necessary to take up any slack.
- Read and observe the warnings ⇒ page 23.

Pregnant women must also fasten their seat belts properly

The best protection for the unborn child is for the mother to wear the seat belt properly at all times during the pregnancy.



Fig. 14 Positioning seat belts during pregnancy ▶

The seat belt provides maximum protection only when the seat belt is properly positioned ⇒ page 26.

- Adjust the front seat and head restraint correctly.
- Holding the latch plate, pull the belt evenly across your chest and as low as possible over the pelvis ⇒ Fig. 14.
- Insert the latch plate into the buckle for the corresponding seat and push it down until it is securely locked with an audible click ⇒ ⚠.
- Pull the belt to ensure that the latch plate is securely engaged in the buckle.

WARNING

- An incorrectly worn seat belt can cause severe injuries in the event of an accident.
- For pregnant women, the lap part of the seat belt must lie as low as possible over the pelvis, never across the stomach, and always lie flat so that no pressure is exerted on the abdomen.
- Read and observe the warnings ⇒ page 23.

Seat belt release

The seat belt must not be unfastened until the vehicle has come to a standstill.

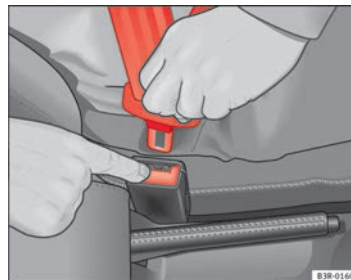

Fig. 15 Remove latch plate from buckle

- Press the red button on the belt buckle ⇒ Fig. 15. The latch plate is released and springs out ⇒ ⚠.
- Guide the belt back by hand so that it rolls up easily and the trim is not damaged.

WARNING

Never unbuckle a seat belt while the vehicle is in motion. If you do, you increase the risk of sustaining severe or fatal injuries.

Incorrectly fastened seat belts

Incorrectly worn seat belts can cause severe or even mortal injuries.

Seat belts can provide optimal protection only if the belt web is properly worn. The seat belts must be fastened exactly in the order described in this chapter. An incorrect sitting position impairs substantially the protection a seat belt offers and can lead to severe or fatal injuries. The risk of severe or fatal injuries is especially increased when a deploying airbag strikes a vehicle occupant who has assumed an incorrect sitting position. As the driver, you are responsible for yourself and all passengers, especially children. Therefore:

- Never allow anyone to wear the seat belt incorrectly while the vehicle is moving ⇒ ⚠.



WARNING

- An incorrectly worn seat belt increases the risk of severe injuries.
- Before every trip, instruct your passengers to adjust their seat belts properly and to wear them for the whole journey.
- Read and always observe information and warnings concerning the use of seat belts ⇒ page 23.

Belt tensioners*

Function of the seat belt tensioner

During a frontal collision, the seat belts on the front seats are retracted automatically.

The seat belts for the occupants in the front seats are equipped with belt tensioners. Sensors will trigger the belt tensioners during severe head-on, lateral and rear collisions only if the seat belt is being worn. This retracts and tightens the seat belts, reducing the forward motion of the occupants.

The seat belt tensioner can be triggered only once.

The belt tensioners will not be triggered in the event of light frontal and side collisions, if the vehicle overturns, or in situations where no large forces act on the front, side or rear of the vehicle.



Note

- If the seat belt tensioners are triggered, a fine dust is produced. This is normal and it is not an indication of fire in the vehicle.
- The relevant safety requirements must be observed when the vehicle or components of the system are scrapped. Specialised workshops are familiar with these regulations, which are also available to you.

Service and disposal of belt tensioners

The belt tensioners are components of the seat belts that are installed in the seats of your vehicle. If you work on the belt tensioners or remove and install parts of the system when performing other repair work, the seat belt may be damaged. The consequence may be that, in the event of an accident, the belt tensioners function incorrectly or not at all. ▶

So that the effectiveness of the seat belt tensioner is not reduced and that removed parts do not cause any injuries or environmental pollution, regulations, which are known to the specialised workshops, must be observed.

**WARNING**

- **Improper use or repairs not carried out by qualified mechanics increase the risk of severe or fatal injuries. The belt tensioners may fail to trigger or may trigger in the wrong circumstances.**
- **Never attempt to repair, adjust, remove or install parts of the belt tensioners or seat belts.**
- **The seat belt tensioner, seat belt and automatic retractor cannot be repaired.**
- **Any work on the belt tensioners and seat belts, including the removal and refitting of system parts in conjunction with other repair work, must be performed by a specialised workshop only.**
- **The belt tensioners will only provide protection for one accident and must be changed if they have been activated.**

Airbag system

Brief introduction

Why wear a seat belt and assume the correct sitting position?

For the inflating airbags to achieve the best protection, the seat belt must always be worn properly and the correct sitting position must be assumed.

For your own safety and the safety of the passengers, please ensure the following before driving:

- Always wear the seat belt properly
- Adjust the driver seat and the steering wheel correctly.
- Adjust the front passenger seat correctly.
- Adjust the head restraint correctly ⇒ page 13.
- Use an appropriate child restraint system to protect children in your vehicle.

The airbag is deployed at high speed in fractions of a second. If you have an incorrect seating position at the time the airbag is deployed, it could cause you critical injuries. Therefore, it is essential that all vehicle occupants assume a correct sitting position while travelling.

Sharp braking before an accident may cause a vehicle occupant not wearing a seat belt to be thrown forward into the area of the deploying airbag. In this case, the inflating airbag may inflict critical or fatal injuries on the occupant. This also applies to children.

Always maintain the greatest possible distance between yourself and the front airbag. This way, the front airbags can completely deploy when triggered, providing their maximum protection.

The most important factors that will trigger an airbag are: the type of accident, the angle of collision and the speed of the vehicle.

Whether the airbags are triggered depends primarily on the vehicle deceleration rate resulting from the collision and detected by the control unit. If the vehicle deceleration occurring during the collision and measured by the control unit remains below the specified reference values, the front, side and/or curtain airbag will not be triggered. Take into account that the visible damage in a vehicle involved in an accident, no matter how serious, is not a determining factor for the airbags to have been triggered.



WARNING

- **Wearing the seat belt incorrectly or assuming an incorrect sitting position can lead to critical or fatal injuries.**
- **All vehicle occupants, including children, who are not properly belted can sustain critical or fatal injuries if the airbag is triggered. Children up to 12 years old should always travel on the rear seat. Never transport children in the vehicle if they are not restrained or the restraint system is not appropriate for their age, size or weight.**
- **If you are not wearing a seat belt, if you lean forward or to the side while travelling or assume an incorrect sitting position, there is a substantially increased risk of injury. This increased risk of injury will be further increased if you are struck by an inflating airbag.**
- **To reduce the risk of injury from an inflating airbag, always wear the seat belt properly.**
- **Always adjust the front seats properly.**

The danger of fitting a child seat on the front passenger seat

Rear-facing child seats must never be used on the front passenger seat when the front passenger airbag is enabled.

The front passenger front airbag is a serious risk for a child if it is activated. The front passenger seat is life threatening to a child if he/she is transported in a rear-facing child seat. Children up to 12 years old should always travel on the rear seat.

If a rear-facing child seat is secured to the front passenger seat, an inflating airbag can strike it with such force that it can cause critical or fatal injuries.

Therefore we strongly recommend you to transport children on the rear seats. That is the safest place for children in the vehicle. Alternatively, the front passenger airbag can be disabled with a key-operated switch ⇒ page 41. When transporting children, use a child seat appropriate to the age and size of each child.

For those vehicles that do not include a key lock switch to deactivate the airbag, the vehicle must be taken to a Technical Service.

WARNING

- If a child seat is secured to the front passenger seat, the risk to the child of sustaining critical or fatal injuries in the event of an accident increases.
- Never secure a rear-facing child seat to the front passenger seat if the front passenger airbag is enabled. The child can suffer critical or fatal injuries if the front passenger airbag is triggered.

WARNING (Continued)

- An inflating front passenger airbag can strike the rear-facing child seat and project it with great force against the door, the roof or the backrest.
- If, under special circumstances, it is necessary to transport a child in a rear-facing child seat on the front passenger seat, it is absolutely essential that you observe the following safety measures:
 - Deactivate the front passenger airbag ⇒ page 41, Deactivating airbags*.
 - Child seats must be approved by the child seat manufacturer for use on a front passenger seat with front or side airbag.
 - Follow the installation instructions of the child seat manufacturer and absolutely observe all warnings
 - Before properly installing the child seat, push the front passenger seat completely backwards so that the greatest possible distance to the front passenger airbag is ensured.
 - Ensure that no objects prevent the front passenger seat from being pushed completely back.
 - The backrest of the front passenger seat must be in an upright position.

Control lamp for airbag and seat belt tensioner

This control lamp monitors the airbag and seat belt tensioner system.

The control lamp monitors all airbags and seat belt tensioners in the vehicle, including control units and wiring connections. ▶

Monitoring of airbag and belt tensioner system

Both the airbag and belt tensioner systems operation is constantly monitored electronically. The control lamp  will light up for a few seconds every time the ignition is switched on (self-diagnosis).

The system must be checked when the control lamp :

- does not light up when the ignition is switched on
- turns off after 4 seconds after the ignition is switched on
- turns off and then lights up again after the ignition is switched on
- lights up or flashes while the vehicle is moving

In the event of a malfunction, the warning lamp remains on continuously. Have the airbag system inspected immediately by a specialised workshop.

If any of the airbags are disabled by a Technical Service, the warning lamp lights for several seconds more after the verification and will turn off if there is no fault.

WARNING

- If there is a malfunction, the airbag and belt tensioner system cannot properly perform its protective function.
- If a malfunction occurred, have the system checked immediately by a specialised workshop. Otherwise, in the event of an accident, the airbag system and belt tensioners may not be triggered, or may not be triggered correctly.

Repairs, maintenance and disposal of airbags

The parts of the airbag system are installed in various places in your vehicle. If work is carried out on the airbag system or parts have to be removed and fitted on the system when performing other repair work, parts of the air-

bag system may be damaged. In the event of an accident this could cause the airbag to inflate incorrectly or not inflate at all.

The relevant safety requirements must be observed when the vehicle or components of the airbag are **scrapped**. Specialised workshops and vehicle disposal centres are familiar with these requirements.

WARNING

- If repairs are not carried out by a professional, or if the airbags are used incorrectly, the risk of severe or fatal injuries is increased. The airbags may fail to inflate, or could inflate in the wrong circumstances.
- Do not cover or stick anything on the steering wheel hub or the surface of the airbag unit on the passenger side of the dash panel, and do not obstruct or modify them in any way.
- It is important not to attach any objects such as cup holders or telephone mountings to the surfaces covering the airbag units.
- To clean the steering wheel or dash panel, you may use only a dry or a water-moistened cloth. Never clean the dash panel and the airbag module surface with cleaners containing solvents. Solvents cause the surface to become porous. If the airbag triggered, plastic parts could become detached and cause injuries.
- Never attempt to repair, adjust, remove or install parts of the airbag system.
- Any work on the airbag system or removal and installation of the airbag components for other repairs (such as repairs to the steering wheel) should be performed only by a specialised workshop. Specialised workshops have the necessary tools, repair information and qualified personnel.
- We strongly recommend you to go to a specialised workshop for all work on the airbag system.
- Never attempt to alter the front bumper or the body.
- The airbags provide protection for just one accident; replace them once they have deployed.

**For the sake of the environment**

The airbags, which are a special type of waste, must be disposed of through an authorised service, because they contain pyrotechnic elements. ■

Front airbags

Description of front airbags

The airbag system is not a substitute for the seat belts.



Fig. 16 Driver airbag located in steering wheel



Fig. 17 Front passenger airbag located in dash panel

The front airbag for the driver is located in the steering wheel ⇒ Fig. 16 and the airbag for the front passenger is located in the dash panel ⇒ Fig. 17. Airbags are identified by the word "AIRBAG".

In conjunction with the seat belts, the front airbag system gives the front occupants additional protection for the head and chest in the event of a severe frontal collision ⇒ page 37, Safety notes on the front airbag system.

In addition to their normal function of restraining the occupants, the seat belts also hold the driver and front passenger in a position where the airbags can provide maximum protection in a frontal collision.

The airbag system is not a substitute for seat belts, but it is an integral part of the vehicle's overall passive safety system. Please bear in mind that the airbag system can only work effectively when the vehicle occupants are wearing their seat belts correctly and have adjusted the head restraints properly. For this reason, it is most important to wear the seat belts at all times, not only because this is required by law in most countries, but also as a contribution to your own safety.

The main parts of the front airbag system are:

- an electronic control and monitoring system (control unit)
- the two front airbags (airbag with gas generator) for the driver and front passenger
- a control lamp  on the dash panel ⇒ page 31

The airbag system operation is monitored electronically. The airbag control lamp will light up for a few seconds every time the ignition is switched on (self-diagnosis).

There is a fault in the system if the control lamp :

- does not light up when the ignition is switched on ⇒ page 31
- turns off after 4 seconds after the ignition is switched on
- turns off and then lights up again after the ignition is switched on
- lights up or flashes while the vehicle is moving



The front airbag system will not be triggered if:

- the ignition is switched off
- there is a minor frontal collision
- there is a side collision
- there is a rear-end collision
- the vehicle turns over



WARNING

- The seat belts and airbags can only provide maximum protection if the occupants are seated correctly ⇒ page 10, Proper sitting position for occupants.
- If a fault has occurred in the airbag system, have the system checked immediately by a specialised workshop. Otherwise, during a frontal collision the system may fail to trigger, or not trigger correctly.

Operation of front airbags

Inflated airbags reduce the risk of injuries to the head or chest.



Fig. 18 Inflated front airbags

The airbag system is designed so that the airbags for the driver and front passenger are triggered in a severe frontal collision.

In certain types of accident the front and side airbags may be triggered together.

When the system is triggered, the airbags fill with a propellant gas and deploy in front of the driver and front passenger ⇒ Fig. 18. The fully deployed airbags cushion the forward movement of the front occupants and help to reduce the risk of injury to the head and the upper part of the body.

The special design of the airbag allows the controlled escape of the propellant gas when an occupant puts pressure on the bag. Thus, the head and chest are surrounded and protected by the airbag. After the collision, the airbag deflates sufficiently to allow visibility. ▶

The airbags deploy extremely rapidly, within thousandths of a second, to provide additional protection in the event of an accident. A fine dust may

develop when the airbag deploys. This is normal and it is not an indication of fire in the vehicle. ■

Airbag covers when the frontal airbags are triggered

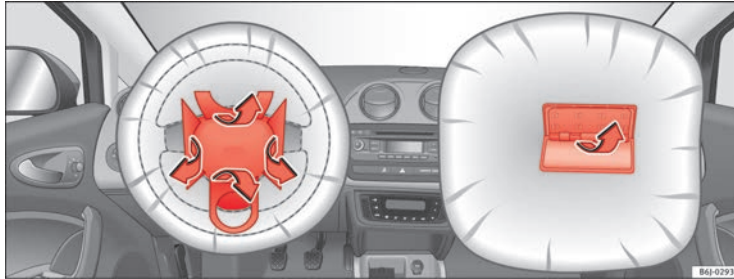

Fig. 19 Airbag covers reacting when the front airbags are triggered

The airbag covers fold out of the steering wheel or dash panel when the driver and front passenger airbags are triggered → Fig. 19. The airbag covers remain connected to the steering wheel or the dash panel. ■

Safety notes on the front airbag system

If you use airbags correctly, they can considerably reduce the risk of injury in many kinds of accident.

WARNING

- It is important for the driver and front passenger to keep a distance of at least 25 cm from the steering wheel and dash panel. If the minimum distance is not observed, the airbags do not correctly protect the vehicle occupants; risk of fatal injuries! In addition, the front seats and head restraints must always be positioned correctly for the height of the occupant.
- If you are not wearing a seat belt, if you lean forward or to the side while travelling or assume an incorrect sitting position, there is a substantially increased risk of injury. This increased risk of injury will be further increased if you are struck by an inflating airbag.
- Never let a child travel on the front seat without an appropriate restraint system. If the airbag is triggered in an accident, children can sustain serious or fatal injuries from the airbag as it inflates ⇒ page 43, Child safety.
- The deployment space between the front passengers and the airbags must not in any case be occupied by other passenger, pets and objects.
- The airbags provide protection for just one accident; replace them once they have deployed.
- It is also important not to attach any objects such as cup holders or telephone mountings to the surfaces covering the airbag units.
- Do not attempt to modify components of the airbag system in any way.

Side airbags

Description of side airbags

The airbag system is not a substitute for the seat belts.



Fig. 20 Side airbag in driver seat

The side airbags are located in the driver seat and front passenger seat backrests ⇒ Fig. 20. The locations are identified by the text "AIRBAG" in the upper region of the backrests.

Together with the seat belts, the side airbag system gives the front seat occupants additional protection for the upper body in the event of a severe side collision ⇒ page 39, Safety notes on the operation of the side airbag system.

In a side collision, the side airbags reduce the risk of injury to passengers on the front seats to the areas of the body facing the impact. In addition to their normal function of protecting the occupants in a collision, the seat belts also hold the passengers on the front seats in a position where the side airbags can provide maximum protection.

The airbag system is not a substitute for seat belts, but it is an integral part of the vehicle's overall passive safety system. Please bear in mind that the airbag system can only work effectively when the occupants are wearing their seat belts. For this reason, it is most important to wear the seat belts at all times, not only because this is required by law in most countries, but also as a contribution to your own safety.

The side airbag system will not be triggered if:

- the ignition is switched off
- there is a minor side collision
- there is a frontal collision
- there is a rear-end collision
- the vehicle turns over

The main parts of the airbag system are:

- an electronic control and monitoring system (control unit)
- the side airbags in the sides of the backrests of the front seats,
- a control lamp  on the dash panel ⇒ page 31

The airbag system operation is monitored electronically. The airbag control lamp will light up for approx. 4 seconds every time the ignition is switched on (self-diagnosis).



WARNING

- **Never drive the vehicle if the interior panels have been removed.**
- **Never drive if the interior door panels have been removed or if the panels have not been correctly fitted.**
- **Never drive the vehicle if the loudspeakers in the door panels have been removed, unless the holes left by the loudspeakers have been correctly closed.**

⚠ WARNING (Continued)

- Always check that the openings are closed or covered if loudspeakers or other equipment are fitted in the interior door panels.
- Any work carried out to the doors should be made in an authorised specialised workshop.
- The seat belts and airbags can only provide maximum protection if the occupants are seated correctly ⇒ page 10, Proper sitting position for occupants.
- If a fault has occurred in the airbag system, have the system checked immediately by a specialised workshop. Otherwise, during a side collision, the system may fail to trigger, or not trigger correctly.

Operation of side airbags

Inflated airbags can reduce the risk of head or chest injury in a side impact collision.

In some **side collisions** the side airbag is triggered on the impact side of the vehicle.

In certain types of accident the front and side airbags may be triggered together.

When the system is triggered, the airbag is filled with propellant gas.

The airbags deploy extremely rapidly, within thousandths of a second, to provide additional protection in the event of an accident. A fine dust may develop when the airbag deploys. This is normal and it is not an indication of fire in the vehicle.

The fully deployed airbags cushion the movement of the occupants of the front seats and help to reduce the risk of injury to the upper body.

The special design of the airbag allows the controlled escape of the propellant gas when an occupant puts pressure on the bag. Thus, the head and chest are surrounded and protected by the airbag.

Safety notes on the operation of the side airbag system

If airbags are used correctly, they can considerably reduce the risk of injury in side impact collisions.

⚠ WARNING

- If you do not wear a seat belt, if you lean forward, or are not seated correctly while the vehicle is in motion, you are at a greater risk of injury if the side airbag system is triggered in an accident.
- In order for the side airbags to provide their maximum protection, the prescribed sitting position must always be maintained with seat belts fastened while travelling.
- Occupants of the outer seats must never carry any objects or pets in the deployment space between them and the airbags, or allow children or other passengers to travel in this position. It is also important not to attach any accessories (such as cup holders) to the doors. This would impair the protection offered by the side airbags.
- The built-in coat hooks should be used only for lightweight clothing. Do not leave any heavy or sharp-edged objects in the pockets.
- Great forces, such as hard blows or kicks, must not be exerted upon the backrest bolster because the system may be damaged. In this case, the side airbags would not be triggered.

 **WARNING (Continued)**

- Under no circumstances should protective covers be fitted over seats with side airbags unless the covers have been approved for use in your vehicle. Because the airbag deploys from the side of the backrest, the use of conventional seat covers would obstruct the side airbag, seriously reducing the airbag's effectiveness.
- Any damage to the original seat upholstery or around the seams of the side airbag units must be repaired immediately by a specialised workshop.
- The airbags provide protection for just one accident; replace them once they have deployed.
- When children assume an incorrect sitting position, they expose themselves to an increased risk of injury in the event of an accident. This is particularly the case if the child is travelling on the front passenger seat and the airbag system is triggered in an accident; this could have critical consequences including serious injury or death ⇒ page 43, Child safety.
- Any work on the side airbag system or removal and installation of the airbag components for other repairs (such as removal of the front seat) should only be performed by a specialised workshop. Otherwise, faults may occur during the airbag system operation.
- Do not attempt to modify components of the airbag system in any way.
- To ensure the correct operation of the side and head airbags neither the doors nor the door panels should be modified in any way (e.g. fitting loudspeakers). If the front door is damaged, the airbag system may not work correctly. All work carried out on the front door must be done in a specialised workshop.

Deactivating airbags*

Front passenger front airbag deactivation

If you fit a rear-facing child seat to the front passenger seat, the front passenger front airbag must be de-activated.



Fig. 21 In the glove compartment: switch for activating and deactivating the front passenger airbag



Fig. 22 Control lamp for deactivated front passenger airbag in centre console

When the front passenger airbag is **deactivated**, this means that only the passenger front airbag is deactivated. All the other airbags in the vehicle remain activated.

Deactivating the front passenger front airbag

- Switch the ignition off.
- Turn the ignition switch in the key operated switch in the glove compartment to the position **OFF** ⇒ Fig. 21.
- Check that the control lamp “PASSENGER AIRBAG OFF” in the dash panel ⇒ Fig. 22 remains lit ⇒ ⚠ when the ignition is switched on.

Activating the front passenger front airbag

- Switch the ignition off.
- Turn the ignition key in the key-operated switch in the glove compartment to the position **ON** ⇒ Fig. 21.
- Check that the control lamp “PASSENGERS AIRBAG OFF” in the dash panel does ⇒ Fig. 22 *not* light up when the ignition is switched on ⇒ ⚠.

WARNING

- The driver is responsible for the proper position of the key-operated switch.
- You should only deactivate the front passenger front airbag when, in exceptional cases, you have to use a rear-facing child seat on the front passenger seat ⇒ page 43, Child safety.

 **WARNING (Continued)**

- Never install a child seat facing backwards on the front passenger seat unless the front passenger front airbag has been disabled. Otherwise, there is a risk of death. If under exceptional circumstances it is necessary to transport a child in a rear-facing child seat on the front passenger seat, you must always disable the front passenger front airbag.
- As soon as the child seat is no longer needed on the front passenger seat, enable the front passenger front airbag again.
- Only deactivate the front passenger front airbag when the ignition is off, otherwise a fault may occur in the airbag system, which could cause the airbag to not deploy properly or not deploy at all.
- When the front passenger front airbag is deactivated, if the control lamp AIRBAG OFF  is not continuously lit up when the front passenger airbag is disabled, there may be a fault in the airbag system:
 - Have the airbag system inspected immediately by a specialised workshop.
 - Do not use a child seat on the front passenger seat! The front passenger front airbag could be triggered despite the fact that there is a fault in the system and, as a result, a child could sustain serious or fatal injuries.
 - It is unpredictable whether the front passenger airbag will deploy in the event of an accident. Warn all your passengers of this.

Child safety

Brief introduction

Introduction

Statistics show that children are generally safer on the rear seat than on the front passenger seat.

For safety reasons we recommend that children under 12 years of age travel on the rear seats. Depending on their age, height and weight, children travelling on the rear seat must use a child seat or a seat belt. For safety reasons, the child seat should be installed in the centre of the rear seat or behind the front passenger seat.

The physical laws involved and the forces acting in a collision apply also to children ⇒ page 21, Why wear seat belts?. But unlike adults, children do not have fully developed muscle and bone structures. This means that children are subject to a greater risk of injury.

To reduce this risk, children must always use special child restraint systems when travelling in the vehicle.

We recommend the use of child safety products from the SEAT Original Accessories Programme, which includes systems for all ages made by Peke¹⁾.

These systems have been especially designed and approved, complying with the ECE-R44. regulation.

Follow the manufacturer's instructions and observe any statutory requirements when installing and using child seats. Always read and note ⇒ page 43, Safety notes on using child seats.

¹⁾ Not for all countries

We recommend you to always include the manufacturer's Child Seat Instruction Manual together with the on-board documentation. ■

Safety notes on using child seats

Proper use of child seats substantially reduces the risk of injury in an accident!

As the driver, you are responsible for any children you transport in your vehicle.

- Protect your children by properly using the appropriate child seats ⇒ page 45.
- Always ensure that the seat belt is properly positioned according to the instructions provided by the manufacturer of the child seat.
- When travelling, do not allow children to distract you from traffic.
- Take breaks regularly during long trips. Take a break at least every two hours. ▶

**WARNING**

- Never install a child seat facing backwards on the front passenger seat unless the front passenger front airbag has been disabled. Risk of potentially fatal injuries to the child! However, if it is necessary, in exceptional cases, to transport a child in the front passenger seat, the front passenger front airbag must always be disabled ⇒ page 41, Deactivating airbags*. If the front passenger seat has a height adjustment option, move it to the highest position.
- For those vehicles that do not include a key lock switch to deactivate the airbag, the vehicle must be taken to a Technical Service.
- All vehicle occupants, especially children, must assume the proper sitting position and be properly belted in while travelling.
- Never hold children or babies on your lap, this can result in potentially fatal injuries to the child!
- Never allow a child to be transported in a vehicle without being properly secured, or to stand up or kneel on a seat while travelling. In an accident, the child could be flung through the vehicle, causing possibly fatal injuries to themselves and to the other vehicle occupants.
- If children assume an improper sitting position when the vehicle is moving, they expose themselves to greater risk of injury in the event of a sudden braking manoeuvre or in an accident. This is particularly important if the child is travelling on the front passenger seat and the airbag system is triggered in an accident; as this could cause serious injury or even death.
- A suitable child seat can protect your child!
- Never leave an unsupervised child alone on a child seat or in the vehicle.
- Depending on weather conditions, it may become extremely hot or cold inside the vehicle. This can be fatal.

**WARNING (Continued)**

- Children who are less than 1.5 metres tall must not wear a normal seat belt without a child seat, as this could cause injuries to the abdominal and neck areas during a sudden braking manoeuvre or in an accident.
- Do not allow the seat belt to become twisted or jammed, or to rub on any sharp edges.
- Incorrectly worn seat belts can cause injuries even in a minor collision or in sudden braking manoeuvres.
- The seat belt provides maximum protection only when the seat belt is properly positioned ⇒ page 25, Seat belts.
- Only one child may occupy a child seat ⇒ page 45, Child seats.

Child seats

Categorisation of child seats into groups

Use only child seats that are officially approved and suitable for the child.

Child seats are subject to the regulation ECE-R 44. ECE-R stands for: Economic Commission for Europe Regulation

The child seats are grouped into 5 categories:

Group 0: up to 10 kg

Group 0+: up to 13 kg

Group 1: from 9 to 18 kg

Group 2: from 15 to 25 kg

Group 3: from 22 to 36 kg

Child seats that have been tested and approved under the ECE R44 standard bear the test mark on the seat (the letter E in a circle with the test number below it).

Group 0 and 0+ child seats

A suitable child seat and a correctly adjusted seat belt can help you to protect your child.

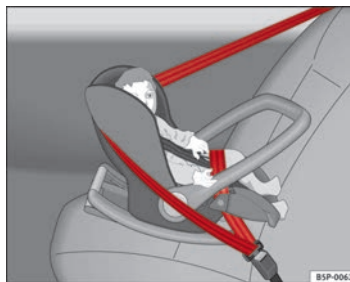

Fig. 23 A group 0 rear-facing child seat fitted on the rear seat

Group 0: For babies up to about 9 months old and 10 kg in weight, the most suitable seats are those appearing in the figure → Fig. 23.

Group 0+: For babies up to about 18 months old and 13 kg in weight, the most suitable seats are those appearing in the figure → Fig. 23.

Follow the manufacturer's instructions and observe any statutory requirements when installing and using child seats.

We recommend you to always include the manufacturer's Child Seat Instruction Manual together with the on-board documentation.

WARNING

Read and always observe information and warnings concerning the use of child seats →  in Safety notes on using child seats on page 44.

Group 1 child seats

A suitable child seat and a correctly adjusted seat belt can help you to protect your child.



Fig. 24 A category 1 forward-facing child seat fitted on the rear seat

Child seats using the ISOFIX system or seats in which the child faces the rear of the vehicle are most appropriate for babies and small children weighing between 9 and 18 kg.

Follow the manufacturer's instructions and observe any statutory requirements when installing and using child seats.

We recommend you to always include the manufacturer's Child Seat Instruction Manual together with the on-board documentation.



WARNING

Read and always observe information and warnings concerning the use of child seats ⇒ ⚠ in Safety notes on using child seats on page 44.

Group 2 and 3 child seats

A suitable child seat and a correctly adjusted seat belt can help you to protect your child.



Fig. 25 Forward-facing child seat installed on rear seat

Follow the manufacturer's instructions and observe any statutory requirements when installing and using child seats.

We recommend you to always include the manufacturer's Child Seat Instruction Manual together with the on-board documentation.

Group 2 child seats

Children *under* 7 years of age weighing between 15 and 25 kg are best protected by group 2 child seats together with properly adjusted seat belts.

Group 3 child seats

Children *over* 7 years of age weighing between 22 and 36 kg but less than 1.5 metres tall are best protected by child seats with head restraints together with properly worn seat belts ⇒ Fig. 25. ▶

**WARNING**

- The shoulder part of the seat belt must lie approximately on the centre of the shoulder, never across the neck or the arm. The seat belt must lie close to the upper part of the body. The lap belt part must lie across the pelvis, not across the stomach, and always fit closely. Pull the belt tight if necessary to take up any slack ⇒ page 25, Seat belts.
- Read and always observe information and warnings concerning the use of child seats ⇒ ⚠ in Safety notes on using child seats on page 44. ■

Securing child seats

Ways to secure a child seat

A child seat can be secured differently on the rear seat and on the front passenger seat.

You can secure a child seat to the rear seat or front passenger seat in the following ways:

- Child seats in groups **0 to 3** can be secured with a seat belt.
- Child seats for groups **0, 0+ and 1** with the ISOFIX system can be secured, without fastening seat belts, with the ISOFIX securing rings
⇒ page 49.

Mass group	Seating position		
	Front passenger seat	Rear side seat	Rear central seat
Group 0 to 10 kg	U*	U	U
Group 0+ to 13 kg	U*	U	U
Group I 9 to 18 kg	U*	U	U
Group II 15 to 25 kg	X	U	U
Group III 22 to 36 kg	X	U	U

- U: Suitable for universal restraint systems for use in this mass group.
- *: Move the front passenger seat as far back as possible, as high as possible and always disable the airbag.
- X: Seat position not suitable for children in this age group.



WARNING

- **When travelling, children must be secured in the vehicle with a restraint system suitable for age, weight and size.**
- **Never install a child seat facing backwards on the front passenger seat unless the front passenger airbag has been disabled. This could cause fatal injuries to the child! However, if, in exceptional cases, it is necessary to transport a child in the front passenger seat, the front passenger airbag ⇒ page 41, Deactivating airbags* must always be disabled and the seat adjusted to its highest position, where possible.**
- **Read and always observe information and warnings concerning the use of child seats ⇒ ⚠ in Safety notes on using child seats on page 44.**

Securing a child seat with the ISOFIX system

Child seats can be secured quickly, easily and safely on the rear outer seats with the ISOFIX system.

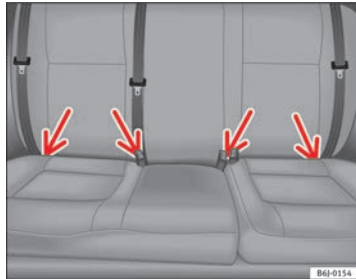

Fig. 26 ISOFIX securing rings

- Press the child seat onto the ISOFIX retaining rings until the child seat can be heard to engage securely. If the child seat is fitted with any other anti-rotation system, follow the manufacturer instructions carefully.
- Pull on both sides of the child seat to ensure that it is secure.

Two ISOFIX retaining rings are fitted on each rear seat. In some vehicles, the rings are secured to the seat frame and, in others, they are secured to the rear floor. The access to the ISOFIX rings is between the rear seat backrest and the seat cushioning.

Child seats with ISOFIX mountings are available in your Technical Services.

When removing or fitting the child seat, please be sure to follow the manufacturer's instructions.

Mass group	Size class	Electrical equipment	Mounting direction	Vehicle Isofix positions
				Rear side seats
Baby carrier	F	ISO/L1	Backward-facing	X
	G	ISO/L2	Backward-facing	X
Group 0 to 10 kg	E	ISO/R1	Backward-facing	IU
	E	ISO/R1	Backward-facing	IU
Group 0+ to 13 kg	D	ISO/R2	Backward-facing	IU
	C	ISO/R3	Backward-facing	IU

Mass group	Size class	Electrical equipment	Mounting direction	Vehicle Isofix positions
				Rear side seats
Group I 9 to 18 kg	D	ISO/R2	Backward-facing	IU
	C	ISO/R3	Backward-facing	IU
	B	ISO/F2	Forward-facing	IU
	B1	ISO/F2X	Forward-facing	IU
	A	ISO/F3	Forward-facing	IU
Group II 15 to 25 kg	---	---	Forward-facing	---
Group III 22 to 36 kg	---	---	Forward-facing	---

IU: Suitable for ISOFIX universal child restraint systems approved for use in this mass group

X: ISOFIX position not suitable for ISOFIX child restraint systems for this mass group or size class



WARNING

- The retaining rings are designed to only be used with ISOFIX child seats.
- Never secure child seats without the ISOFIX system, retaining belts or objects to the fastening rings – this can result in potentially fatal injuries to the child.
- Ensure that the child seat is secured correctly to the ISOFIX anchor points.

Top Tether retainer straps

Some child restraint seats have a third Top Tether anchoring point, apart from both “ISOFIX” anchoring points, which allow better child retention.



Fig. 27 Position of the Top Tether rings on the back of the rear seat

Child seats with the Top Tether system come with a strap for securing the seat to the vehicle anchor point, located at the back of the rear seat backrest. ▶

The retainer strap is used to reduce forwards movements of the safety seat in a crash, helping reduce the risk of injuries to the head from hitting the inside of the vehicle.

It is foreseen that an EU Directive will introduce requirements related to the retention of child restraint systems by means of ISOFIX and Top Tether anchorages (probably compulsory for new types from 2010), which will entail improved retention of the child restraint seat and less head movement in case of frontal collisions.

Use of retainer straps on rear-facing seats

At present there are very few rear-facing child safety seats fitted with a retainer strap. Please carefully read and follow the safety seat manufacturer's instructions for information on how to install the retainer strap properly.

WARNING

An undue installation of the safety seat will increase the risk of injury in the event of a crash.

- Never tie the retainer strap to a hook in the luggage compartment.
- Never secure or tie luggage or other items to the lower anchorages (ISOFIX) or the upper ones (Top Tether).

Fitting the Top Tether child restraint to the anchoring point

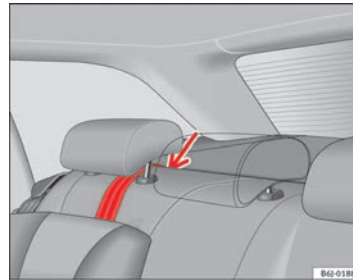

Fig. 28 Retainer strap: correct adjustment and fitting

Securing the Top Tether child restraint to the anchor point situated on the rear of the backrest

- Pull out the fastening belt of the child restraint seat according to the manufacturer's instructions.
- Guide the Top Tether fastening belt under the rear seat head restraint => Fig. 28 (lift the head restraint where necessary).
- Slide the belt so that the Top Tether belt of the child restraint seat is correctly secured to the anchor on the back of the rear seat.
- Firmly tighten the Top Tether belt following the child restraint seat manufacturer's instructions.

Releasing the retaining strap

- Release the retainer strap in line with the instructions given by the child safety seat manufacturer. ▶

- Push the lock and release it from the anchoring support.

**WARNING**

Read and bear in mind all the WARNINGS ⇒ page 50.

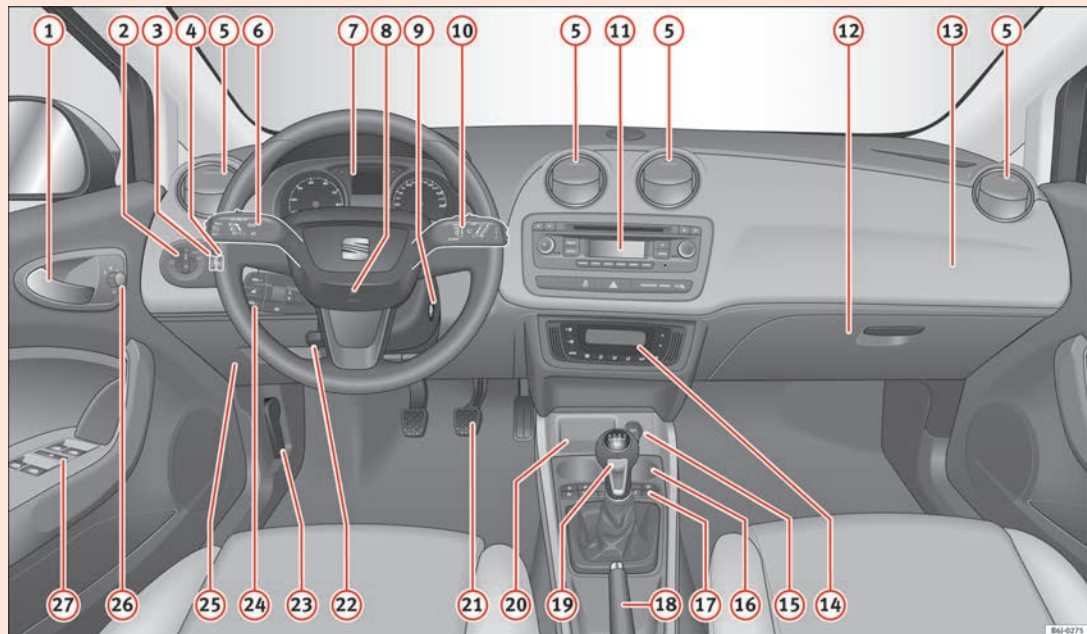

Fig. 29 Dash panel

Operating Instructions

Cockpit

Overview

Overview of the dash panel

This overview will help you to familiarise yourself with the controls and displays.

①	Door release lever	
②	Light switch	100
③	Light dimmer for instrument panel lighting*	102
④	Headlight range control*	102
⑤	Air vents	
⑥	Lever for:	
	– turn signals/dipped beam	106
	– cruise control*	164
⑦	Instrument panel and warning lamps:	
	– Instruments	57
	– Control and warning lamps	65
⑧	Horn (only works when the ignition is on)/ and driver front airbag*	30
⑨	Steering and starter lock	145
⑩	Lever for:	
	– windscreen wiper/washer	109
	– rear window wiper/washer*	109
	– multifunction display*	61
⑪	Radio	
⑫	Glove compartment/Storage compartment	122
⑬	Passenger airbag*	34
⑭	Switches for:	
	– Heating and ventilation	134
	– Air conditioning*	137
	– Climatronic*	140
⑮	Cigarette lighter / Power socket	125
⑯	Drink holder/Ashtay	124
⑰	Controls on the centre console:	
	- Start-Stop operation button	150
	- LPG gas system control button	149
	- Tyre pressure monitoring*	73
	- Heated rear window	104
	- Heated seats*	119
	- Central locking*	85
	Dash panel switches:	
	- ESC OFF	145, 170
	- Hazard warning lights	105
	- Airbag disconnection warning lamp*	31, 41
⑱	Handbrake lever	161
⑲	Gear lever	
	– automatic*	154
	– manual	153 ▶

20	Storage space	
21	Pedals	16
22	Steering column control lever*	144
23	Bonnet release lever	202
24	Steering column controls for audio and telephone*	78
25	Fuse housing	231
26	Control for adjusting electric exterior mirrors*	113
27	Electric window controls*	95

**Note**

Some of the items of equipment listed here are fitted only on certain model versions or are optional extras. ■

Instruments

Instrument overview

The instruments display the vehicle operating status.



Fig. 30 Detailed view of the dash panel: instrument panel

The layout of the instruments depends upon the model and the engine.

- ① Rev counter* ⇒ page 58
- ② Digital display ⇒ page 59
- ③ Speedometer ⇒ page 58
- ④ Menu selection button on the instrument panel digital display
- ⑤ Adjustment button depending on the selected menu

Rev counter

The rev counter displays the engine speed in revolutions per minute.

The start of the red zone ⇒ Fig. 30 ① indicates the maximum engine speed operating at service temperature. However, it is advisable to change up into a higher gear, move the selector lever to D or lift your foot off the accelerator before the needle reaches the red zone.

! CAUTION

To prevent possible engine malfunctions, the rev counter needle should not reach the red zone. The start of the red zone on the dial is different for some engine versions.



For the sake of the environment

Changing up into higher gears sooner, following the recommended gear indications ⇒ Fig. 33 will help you to reduce fuel consumption, emissions and also engine noise.

Speedometer

The speedometer is equipped with a digital odometer and a trip recorder, in addition to a service intervals display.

During the running-in period, the instructions shown on ⇒ page 173 should be followed.

¹⁾ Depending on the model version

LPG system*

LPG gauge



Fig. 31 Instrument panel: gas gauge.

LPG system filler level display

The LPG tank ⇒ ⚠ in the spare wheel well has a capacity of 52.8 litres at an outside temperature of 15°C ⇒ page 196, Refuelling with LPG.

The charge level can be checked on the analogue gas gauge located on the instrument panel ⇒ Fig. 31. When the level reaches reserve, the gas reserve warning lamp lights up and an audible warning is heard. Refill with LPG at the earliest opportunity.

If, while driving in LPG mode, a sudden audible warning is heard and the warning **ERROR FUNC. A GAS** is displayed on the screen¹⁾, it means that there is a fault in the LPG system. Take the vehicle to a specialised workshop to check the LPG system.

**WARNING**

LPG is a highly explosive and inflammable substance. It may cause severe burns and other injury.

- Due care must be taken to avoid any risk of fire or explosion.
- When parking the vehicle in a closed area (for example in a garage), make sure that there is adequate ventilation, either natural or mechanical, to neutralise the LPG in the event of a leak.

**Note**

- The values shown in the average fuel consumption and distance to empty indications on the multifunction display (MFI)¹⁾ on the instrument panel²⁾ are approximate values only.
- Two different consumption values are given on the MFI, depending on whether the vehicle is running in GAS or Petrol mode.
- Please check the fuel level on the fuel level gauge on the instrument panel → page 59
- If frequent short journeys are made, especially when the outside temperature is low, the vehicle will tend to run on petrol more often than on LPG. Therefore, the petrol tank may empty before the LPG tank.

¹⁾ Optional equipment

²⁾ Depending on the model version

Digital instrument panel display

Fuel gauge and reserve indicator



Fig. 32 Fuel gauge

Instrument panel: fuel gauge

The fuel tank has a capacity of approx. 45 litres.

When the needle reaches the reserve zone → Fig. 32, the warning lamp will light and an audible warning will sound **reminding the driver to refuel**. At this point there are still 7 litres of fuel in the tank.

Digital clock*

- To set the hour, press button ④ ⇒ Fig. 30. The “hour” option flashes on the digital display and is set using button ⑤ “set” ⇒ Fig. 30.
- To set the minutes, press button ④ again and select the minute option. Set from button ⑤ “set”.

Once the operation has been carried out, the system memorises the time. ■

Outside temperature indicator

The outside temperature is displayed when the ignition is switched on.

In addition to the outside temperature display, an ice crystal is displayed and, if vehicle speed is over 10 km/h (6 mph), a warning tone is heard at temperatures dropping from between +4°C and -7°C and at temperatures rising from -5°C up to +6°C.

The lighting of the crystal symbol aims to warn the driver of the risk of ice, so that he/she proceeds with due care.

When the vehicle is stationary or travelling at very low speeds, the temperature displayed may be slightly higher than the actual outside temperature as a result of heat coming from the engine. ■

Recommended gear display*

This display helps to save fuel.

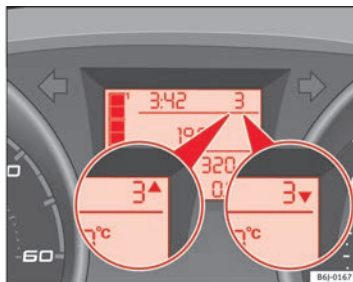

Fig. 33 Gear display

Use the gear display to save fuel. If you are not in the correct gear, a triangle will appear next to the gear display indicating whether you should change up or down ⇒ Fig. 33.



Note

The gear change indication should not be taken into account the acceleration is required (for example when overtaking). ■

Multifunction display (MFI)*

The multifunction display (MFI) shows you information on the journey and fuel consumption.

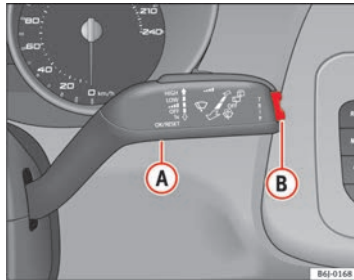

Fig. 34 Window wiper lever: button A and rocker switch B

The multifunction system uses two automatic memories: **1 - Trip memory** and **2 - Total memory**. The selected memory will be shown in the upper right-hand corner of the display.

Selecting a memory

- With the ignition switched on, briefly press button ⇒ Fig. 34 **A** on the window wiper lever to move from one memory to another.

Resetting a memory

- Select the memory that you would like to reset.
- Press and hold button **A** on the window wiper lever for at least 2 seconds.

The **trip memory 1** collects the travel and consumption rates from the moment the ignition is switched on until it is switched off. If the journey is continued within two hours of switching off the ignition, the new values will be added to the existing trip recorder memory. The memory will automatically be deleted if the journey is interrupted for more than two hours.

The **total memory 2** collects the trip data for any number of individual journeys (even if the ignition is switched off for longer than two hours) up to a total of 19 hours and 59 minutes travel time or 1999 km (miles) distance travelled. The memory will automatically be deleted if one of the named values is reached.

Information in the multifunction display (MFI)*

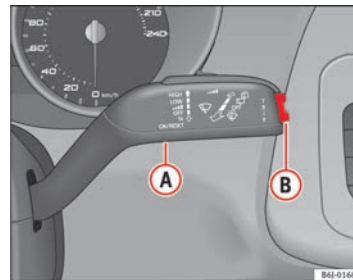

Fig. 35 Windscreen wiper and windscreen wash lever: button A and rocker switch B

You can switch between the following displays in the multifunction display (MFI) by operating rocker switch ⇒ Fig. 35 **B** on the window wiper lever.

Memory displays

- Driving speed
- Journey duration

- Average speed
- Distance
- Fuel range
- Average fuel consumption
- Current fuel consumption
- Outside temperature indicator
- Speed warning

Km/h (mph) - Driving speed

Driving speed is digitally shown in the display.

min - Journey duration

The display shows the amount of time which has elapsed since the ignition was switched on.

The maximum display value in both memories is 19 hours and 59 minutes. The memory will automatically be deleted once this value has been reached.

Ø km/h (mph) - Average speed

After turning on the ignition, the average speed will be shown after travelling a distance of approximately 100 metres. Until then dashes will appear in the display. The display will be updated every 5 seconds while the vehicle is in motion.

km (miles) - Distance travelled

The display shows the distance travelled since the ignition was switched on.

The maximum display value in both memories is 1999 km (miles). The memory will automatically be deleted once this value has been reached.

Km (miles) - Fuel range

The fuel range is calculated using the figures for tank content and current fuel consumption. It shows how far the vehicle can travel using the same conditions as a reference.

Ø ltr/100 km - Average fuel consumption

After turning on the ignition, average fuel consumption will be shown after travelling approximately 100 metres. Until then dashes will appear in the display. The display will be updated every 5 seconds while the vehicle is in motion. The amount of fuel used will not be shown.

l/100 km or l/h - Current fuel consumption

The display will show the current fuel consumption in litre/km whilst the vehicle is in motion or in litre/hour when the vehicle is in a stationary position with the engine running.

Using this display you can see how your driving style affects fuel consumption ⇒ page 173.

Outside temperature indicator

The measurement range extends from -45°C to +58°C. At temperatures below +4°C, an ice crystal symbol is displayed and a “gong” warning sounds if the vehicle is moving at more than 10 km/h (6 mph) (ice danger warning). This symbol will flash for about 10 seconds and remains lit until the outside temperature rises above +4°C or does not rise above 6°C when on the move if it was already lit.

Set speed indicator

When the required speed has been reached, enter the “Speed warning” mode menu and press button **(A)**-RESET-. The set speed is memorised. If the indicated speed is exceeded at any time, a warning message is displayed on the screen and an audible warning sounds.¹⁾

¹⁾ Depending on the model version, the message on the screen may vary and may be represented by flashing of the speed indication or by a speed message.

This may be deactivated by pressing the (RESET) button. The speed may be altered using the rocker switch (B) in steps of 5 km/h (mph) within 5 seconds of the initial memory value.

WARNING

There could be black ice on the road surface even if the “snowflake symbol” is not shown. For this reason you should not rely exclusively on this display - Risk of accident!

Note

When the vehicle is stationary or travelling at very low speeds, the temperature displayed may be slightly higher than the actual outside temperature as a result of the heat radiated from the engine.

Display field for selector lever position*



Fig. 36 Digital display:
Gearbox lever position
for automatic gearbox.

The position of the automatic selector lever is shown on the display → page 154.

Odometer

The upper counter in the display registers the total mileage covered by the vehicle.

The lower counter registers the short journeys. The last digit indicates 100-metre sections. The trip recorder counter may be reset by pressing the reset button → Fig. 30 (5).

Service interval display



Fig. 37 Service interval
display

The service indication is shown on the instrument panel display → Fig. 37.

SEAT distinguishes between services *with* engine oil change (e.g. Interval service) and services *without* engine oil change (e.g. Inspection Service). ▶

The service interval display only indicates the dates of services that include engine oil change. The dates of all other services, such as Inspection Service or brake fluid change, appear in the sticker on the door pillar or in the Maintenance Programme.

Vehicles with **service intervals dependent on time/distance travelled** already have certain service intervals set.

The intervals are calculated separately in vehicles with **LongLife service**. Technical progress has made it possible to considerably reduce servicing requirements. With the LongLife System, SEAT ensures that your vehicle only has an interval service when it is necessary. To calculate this (max. two years), the conditions under which the vehicle is used and the individual driving style are also taken into account. The service pre-warning will appear at 20 days or less prior to the corresponding service. The distance travelled is rounded off to the nearest 100 km (miles) and the time to full days. The current service message can only be consulted 500 km (miles) or more after the last service. Until that time, only dashes are displayed.

Service warning

A **service warning** will appear when the ignition is switched on if a service is due soon.

The instrument panel display will show the “spanner symbol”  and the “km (miles)” indication, along with a clock symbol with the days remaining until the date of the next service. The figure indicated is the maximum number of kilometres (miles) remaining before the date of the next service. The indication changes after a few seconds. A “clock symbol” appears and the number of days until the service appointment should be carried out.



Service

If a service is due, an audible warning will sound and the flashing “spanner”  symbol will be shown along with the fixed text **SERVICE**.

If **no service is carried out** following the indication on the instrument panel, the excess distance travelled and the excess time following the **SERVICE** warning will be displayed.

Reading the service message



The **current service message** can be consulted with the ignition on, the engine switched off and the vehicle at a standstill:

- Press the  button on the instrument panel as often as necessary until the spanner symbol  is displayed.

An **overdue service** is indicated by a minus sign in front of the mileage or day information.

Resetting service interval display

If the service was not performed by a SEAT dealership, the display must be reset as follows:

- Switch the ignition off.
- Press and hold the  button.
- Switch ignition back on.
- Release the  button and press the  button within 20 seconds.

Do **not** reset the display between service intervals, as the display will otherwise be incorrect.

If the display is reset manually, the next service interval will be indicated after 15 000 km (10 000 miles) or one year and will not be calculated individually.



Note

In LongLife Service vehicles, if the battery is disconnected for a long period, the days remaining until the next service cannot be calculated. Therefore, the service message indications may be incorrect. In this case, bear in mind the maximum service intervals permitted in the  Booklet Maintenance Programme. ■

Warning lamps

Overview of the warning lamps

The control lamps indicate a number of different functions and possible faults.

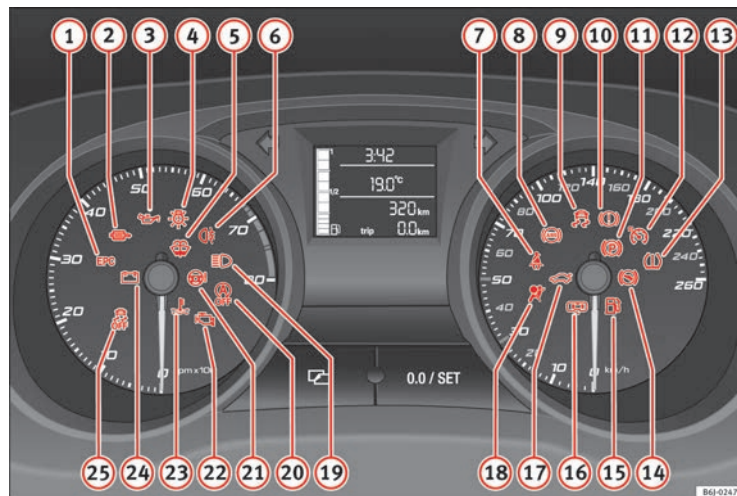



























Fig. 38 Instrument panel warning and control lamps. Some of the items of equipment listed here are fitted only on certain model versions or are optional extras. ▶

Item	Symbol	Meaning of control and warning lamps	Further information
①		Engine fault (petrol engine)	⇒ page 69
①		Glow plug system for diesel engine If lit: glow plug system active If flashing: engine fault	⇒ page 70
②		Soot accumulation in the diesel engine particulate filter	⇒ page 70
③		Red: Engine oil pressure Yellow: If flashing: engine oil sensor faulty If it remains lit: insufficient engine oil	⇒ page 70
④		Bulb defective	⇒ page 71
⑤		Level of liquid for washing windows too low.	⇒ page 71
⑥		Rear fog light switched on	⇒ page 71
⑦		Seat belt warning lamp*	⇒ page 20
⑧		Anti-lock brake system (ABS) *	⇒ page 71
⑨		If flashing: the Electronic Stability Control (ESC) is working or the ASR is working If it remains lit: ESC or ASR faulty	⇒ page 72 ⇒ page 72
⑩		Brake fluid required or serious fault in brake system	⇒ page 73
⑪		Handbrake on	⇒ page 161

Item	Symbol	Meaning of control and warning lamps	Further information
⑫		Cruise speed activated (Cruise control)	⇒ page 73
⑬		Tyre pressure*	⇒ page 73
⑭		Selector lever lock (automatic gearbox)	⇒ page 74
⑮		Fuel level / reserve	⇒ page 74
⑯		Doors open	⇒ page 74
⑰		Rear lid open	⇒ page 74
⑱		Airbag or belt tensioner system fault or airbag disabled	⇒ page 31
⑲		Main beam switched on	⇒ page 75
⑳		Start-Stop system switched off	⇒ page 150
㉑		Electro-hydraulic steering	⇒ page 75
㉒		Fault in the emission control system	⇒ page 75
㉓		Coolant level / coolant temperature	⇒ page 75
㉔		Alternator fault	⇒ page 76
㉕		If it stays lit: ASR switched off	⇒ page 72 ⇒ page 72 ▶

Item	Symbol	Meaning of control and warning lamps	Further information
	↔	Turn signals in operation	⇒ page 76
	SAFE	Electronic immobiliser	⇒ page 76 ⇒ page 82

WARNING

- Failure to observe control lamps and warning messages can result in serious personal injuries or damage to your vehicle.
- The risk of an accident increases if your vehicle breaks down. Use a warning triangle to draw the attention of other road users in order to prevent danger to third parties.
- The engine compartment is a dangerous area! Before you open the bonnet to work on the engine or in the engine compartment, you must switch the engine off and allow it to cool to reduce the risk of scalding or other injuries. Read and observe the relevant warnings ⇒ page 200.



Note

- The appropriate control lamp for a fault will light up in vehicles without warning or information messages in the display.
- In vehicles with warning or information texts on the screen, the appropriate control lamp for a fault will light up and a warning or information message will also appear on the screen.

Overview of indicator and warning lamps (vehicles with LPG)

The control lamps indicate a number of different functions and possible faults.

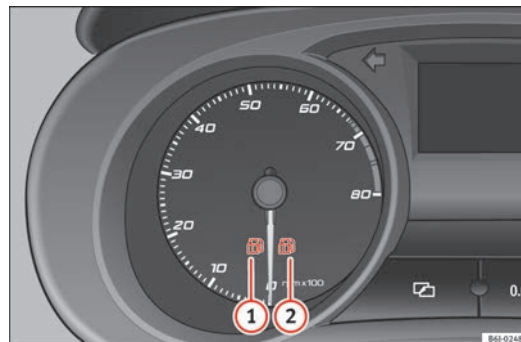



Fig. 39 Instrument panel control and warning lamps in vehicles with LPG.

Item	Symbol	Meaning of control and warning lamps	Further information
①		Green: LPG system connected	⇒ page 149
②		Yellow: Gas reserve warning light	⇒ page 58

**WARNING**

- Failure to observe control lamps and warning messages can result in serious personal injury or damage to your vehicle.
- The risk of an accident increases if your vehicle breaks down. Use a warning triangle to draw the attention of other road users in order to prevent danger to third parties.
- The engine compartment is a dangerous area! Before you open the bonnet to work on the engine or in the engine compartment, you must switch the engine off and allow it to cool to reduce the risk of scalding or other injuries. Read and observe the relevant warnings ⇒ page 200.

**Note**

- The appropriate control lamp for a fault will light up in vehicles without warning or information messages in the display.
- In vehicles with warning or information texts on the screen, the appropriate control lamp for a fault will light up and a warning or information message will also appear on the screen.

Warning symbols

There are red warning symbols (priority 1) and yellow warning symbols (priority 2)

Warning messages, Priority 1 (red)



If one of these faults occurs, the warning lamp will flash or light up and will be accompanied by **three audible warnings**. This is a **danger** warning. Stop the vehicle and switch off the engine. Check the fault and correct it. Obtain professional assistance if necessary.

¹⁾ Depending on the version of the model.

If several priority 1 faults are detected at the same time, the symbols will be displayed one after the other for about 2 seconds at a time and will continue until the fault is corrected.

No menus will be shown in the display for the duration of a priority 1 warning message.

Examples of priority 1 warning messages (red)

- Brake system symbol  with the warning message **STOP BRAKE FLUID INSTRUCTION MANUAL** or **STOP BRAKE FAULT INSTRUCTION MANUAL**.
- Coolant symbol  with the warning message **STOP SEE COOLANT INSTRUCTION MANUAL**.
- Engine oil pressure symbol  with the warning message **STOP ENGINE OIL PRESSURE LOW! INSTRUCTION MANUAL**.

Warning messages, Priority 2 (yellow)

If one of these faults occurs, the warning lamp lights up, and is accompanied by **one audible warning**. Check the corresponding function as soon as possible although the vehicle may be used without risk.

If several priority 2 warning messages are detected at the same time, the symbols are displayed one after the other for about 2 seconds at a time. After a set time, the information text will disappear and the symbol will be shown as a reminder at the side of the display.

Priority 2 warning messages will not be shown until all **Priority 1** warning messages have been dealt with!

Examples of priority 2 warning messages (yellow):¹⁾

- Fuel warning light with the information text **PLEASE REFUEL**.

Information messages displayed on the screen*

Message ^{a)}	Description
SERVICE	The service interval has ended. Take the vehicle to a Technical Service.
IMMOBILISER	Immobiliser system active. The vehicle will not start. Take the vehicle to a Technical Service.
ERROR	Instrument panel faulty. Take the vehicle to a Technical Service.
CLEAN AIR FILTER	Warning: Clean the air filter.
NO KEY	Warning: Correct key cannot be found in the vehicle.
KEY BATTERY	Warning: Key battery low. Change the battery.
CLUTCH	Warning: Press the clutch to start. In vehicles with manual gearbox and Start/Stop system.
--> P/N	Warning: Place the selector level in P/N to start. Only in vehicles with automatic gearbox.
--> P	Warning: Place the selector lever in position P to stop the engine.
STARTING	Warning: The engine starts automatically. Start-Stop system activated.
START MANUALLY	Warning: The engine must be started manually. Start-Stop system activated.
ERROR START STOP	Warning: Start-Stop system error.
START-STOP IMPOSSIBLE	Warning: Although the Start-Stop system is switched on, the engine cannot be stopped automatically. Not all the necessary conditions are met.
START-STOP ACTIVE	Warning: Start-Stop system activated. Vehicle in Stop mode.
SWITCH OFF	Warning: Start-Stop system activated. Switch off the ignition when you leave the vehicle.

STOP TRANSMISSION TOO HOT	Warning: Stop the engine. Gearbox overheated.
BRAKE	Warning: To start the engine, press the brake pedal. Only in vehicles with automatic gearbox.
COASTING FUNCTION	Warning: Coasting mode active. Transmission engaged. Only in vehicles with automatic gearbox.
CHECK SAFE-LOCK	Notification of central locking function activated.

^{a)} These messages may vary according to the version of the vehicle model.

Engine management* EPC

This warning lamp monitors the engine management system for petrol engines.

The warning lamp **EPC** (Electronic Power Control) lights up when the ignition is switched on to show that the lamp is working properly. It should go out once the engine is started.

If there is a fault in the electronic engine management system while you are driving, this warning lamp will light up. Stop the vehicle and seek technical assistance.

Glow plug system/Engine fault*

The warning lamp lights up to show that the glow plugs are preheating the diesel engine. It flashes if there is an engine fault.

Control lamp is lit

The control lamp  lights up while the glow plug system is preheating. When the warning lamp goes off, the engine should be started straight away.

Control lamp flashes





If a fault develops in the engine management system while you are driving, the glow plug system lamp will flash . Take the vehicle to a specialised workshop as soon as possible and have the engine checked.

Soot accumulation in the diesel engine particulate filter*



If the lamp  lights up you should help the filter clean itself by driving in the appropriate manner.

To do this, drive about 15 minutes in fourth or fifth gear (automatic gearbox: S gear range) at a speed of 60 km/h (40 mph), with the engine running at approximately 2000 rpm. In this way, the pollen build up in the filter is burned. When cleaning is successful, the lamp turns off.

If the lamp  does not turn off, or the three lamps turn on (particulate filter , emission control system fault  and glow plugs ), take the vehicle to a specialised workshop to repair the fault.



WARNING

- Always drive according to the road weather conditions, the terrain and traffic. Driving recommendations should never lead to illegal manoeuvres in surrounding traffic.
- The diesel engine particulate filter may reach extremely high temperatures; it should not enter into contact with flammable materials underneath the vehicle. Otherwise there is a risk of fire.

Engine oil pressure

If this warning lamp is red it indicates that the engine oil pressure is too low.

If this warning symbol starts to flash, and is accompanied by three **audible warnings**, switch off the engine and check the oil level. If necessary, add more oil → page 206.

If the symbol flashes although the oil level is correct, *do not* drive on. Do not even run the engine at idle speed! Obtain technical assistance.

Checking the oil level

If the warning lamp is yellow  the engine oil level should be checked as soon as possible. Top up the oil → page 206 at the next opportunity.

Oil level sensor faulty*

If the  yellow warning lamp flashes, take the vehicle to a specialised workshop to have the oil level sensor checked. Until then it is advisable to check the oil level every time you refuel.

Bulb defect*

The indicator lights up when a bulb is not functioning.

The  warning lamp lights up when there is a fault on the turn signals, headlights, side lights and fog lights.

Washer fluid

This warning lamp lights up to indicate that the windscreen washer level is too low.

This serves as a reminder to fill up the reservoir at the earliest opportunity ⇒ page 209.

Rear fog light*

This warning lamp lights up when the rear fog light is switched on . For further information see ⇒ page 100.

Anti-lock brake system (ABS)*

A control lamp monitors the ABS.

The control lamp  should light up for a few seconds when the ignition is switched on. It goes out again after the system has run through an automatic test sequence.



There is a fault in the ABS if:

- The control lamp  does not light up when the ignition is switched on.
- The control lamp does not go out again after a few seconds
- The control lamp lights up when the vehicle is moving

The vehicle can still be braked in the normal way, without the ABS function. Take the vehicle to a specialised workshop as soon as possible. For further information on the ABS go to ⇒ page 169.



If there is a fault in the ABS, the ESC* and the tyre pressure control lamp will also light up.

Brake system fault

If the ABS warning lamp  lights up together with the brake warning lamp , this indicates not only a fault in the ABS function, but also a possible fault in the brake system ⇒ .



WARNING

- Before opening the bonnet, read and observe the warnings on ⇒ page 200, Working in the engine compartment.
- If the brake system warning lamp  should light up together with the ABS warning lamp , stop the vehicle immediately and check the brake fluid level in the reservoir ⇒ page 213, Brake fluid. If the brake fluid level has dropped below the "MIN" mark you must not drive on. Risk of accident. Obtain technical assistance.
- If the brake fluid level is correct, the fault in the brake system may have been caused by a failure of the ABS system. This could cause the rear wheels to lock quickly when you brake. This could cause the rear to break away. Risk of skidding. Stop the vehicle and seek technical assistance.



Differential lock fault (EDL)*

*The EDL operates along with the ABS in vehicles equipped with the Electronic Stability Control (ESC)**

A malfunction in the EDL is indicated by the ABS control lamp . Take the vehicle to a specialised workshop as soon as possible. For further information on the EDL see ⇒ page 171, Electronic differential lock (EDL)*. ■

Traction control system (ASR)* /

The traction control system prevents the driven wheels from spinning when the vehicle is accelerating

There are two warning lamps for the traction control system:  and . Both warning lamps light up together when the ignition is switched on and should turn off after approximately 2 seconds. This is the time taken for the function check.

The  lamp has the following function:

- It flashes when the ASR is working if the vehicle is moving.



If the system is deactivated or if it has any fault, the warning lamp will remain lit. The warning lamp will also light up if a fault should occur in the ABS because the ASR operates in conjunction with the ABS. For further information, see ⇒ page 168, Brakes

The  lamp provides information about the disconnection status of the system:

- It stays lit when the ASR is disconnected when pressing the  switch.

By pressing it again, the ASR function is reactivated and the warning lamp switched off. ■

Electronic Stability Control (ESC)* /

There are two warning lamps for the Electronic stability control. The  lamp provides information concerning the function and the  provides information on the disconnection status

Both warning lamps light up together when the ignition is switched on and should turn off after approximately 2 seconds. This is the time taken for the function check.

This programme includes the ABS, EDL and ASR. It also includes emergency braking assistance (BAS).

The warning lamp  has the following functions:

- It flashes whilst driving when the ASR/ESC is activated.
- It will light up continuously if there is a fault in the ESC.
- As the ESC operates in conjunction with the ABS, it will also light up if a fault should occur in the ABS.

If the ESC control lamp  lights up and stays on after the engine is started, this may mean that the control system has temporarily switched off the ESC. In this case the ESC can be reactivated by switching the ignition off and then on again. If the control lamp goes out, this means the system is fully functional.

The  lamp provides information about the disconnection status of the system:

- It stays lit when the ASR is disconnected when pressing the  switch. ■

Brake system* (P)

This warning lamp lights up if the brake fluid level is too low or if there is a fault in the system.

This warning lamp (P) lights up if

- the brake fluid level is too low ⇒ page 213.
- there is a fault in the brake system.

This warning lamp can light up together with the ABS system warning lamp.

WARNING

- If the brake warning lamp does not go out, or if it lights up when driving, the brake fluid level ⇒ page 213, Brake fluid in the reservoir is too low. Risk of accident. Stop the vehicle and do not drive on. Obtain technical assistance.
- If the brake warning lamp (P) lights up together with the ABS warning lamp (ABS), the control function of the ABS could be out of action. This could cause the rear wheels to lock quickly when you brake. This could cause the rear to break away. Risk of skidding. Stop the vehicle and seek technical assistance.

Cruise speed (Cruise control)* (S)

The warning lamp comes on when the cruise control system is switched on.

The warning lamp (S) lights up when the cruise control system is switched on. For further information on the cruise control system, see ⇒ page 164.

¹⁾ Depending on the model version

Tyre pressure* (L)



Fig. 40 Centre console: tyre monitor system button

The tyre control lamp¹⁾ compares wheel revolutions and with it, the wheel diameter of each wheel using the ESC. If the diameter of a wheel changes, the tyre control lamp (L) lights up. The wheel diameter changes when:

- Tyre pressure is insufficient.
- The tyre structure is damaged.
- The vehicle is unbalanced because of a load.
- The wheels of one axle are under more pressure (for example, driving with a trailer or on extreme slopes).
- The vehicle is fitted with snow chains.
- The temporary spare wheel is fitted.
- The wheel on one axle is changed.

Tyre pressure adjustment

Following the modification to tyre pressure or changing one or more wheels, the button ⇒ Fig. 40 must be kept pressed while the ignition is on until an audible warning is heard.

If the wheels are under excessive load (for example, driving with a trailer or heavy load), the tyre pressure must be increased to the recommended value for a full load (see the sticker on the inside of the fuel flap). If the tyre monitor system button is pressed down, the new tyre pressures are confirmed.

The tyre pressure control lamp lights up

If the tyre pressure of a wheel is much lower than the value set by the driver, then the tyre pressure control lamp ⇒  will light up.



WARNING

- When the tyre pressure control lamp lights up, reduce speed immediately and avoid any sudden manoeuvre or braking. Stop when possible, and check the tyre pressure and status.
- The driver is responsible for maintaining correct tyre pressures. For this reason, tyre pressure must be regularly checked.
- Under certain circumstances (for example, when driving in a sports-like manner, in winter conditions or on a dirt track) the tyre control lamp may light up or function incorrectly.



Note

If the battery is disconnected, the yellow warning lamp  lights up after turning the ignition on. This should turn off after a brief journey.

Speed selector lever lock*

The brake pedal must be depressed when this warning lamp lights up. This is necessary when the automatic gearbox* selector lever is moved out of the positions **P** or **N**. ■

Fuel level/reserve

This symbol lights up to indicate that the fuel tank is under the reserve level.

It lights up when only 7 litres of fuel remain in the tank. Moreover, an **audible warning*** is heard. It reminds you to fuel up the fuel tank as soon as possible ⇒ page 194. ■

Indicates that the doors are open*

This warning lamp lights up if one of the doors or the rear lid is open.

The warning light  should go off when all the doors are closed correctly. ■

Rear lid open*

The warning lamp  should switch off when the rear lid is fully closed. ■

Main beam headlights

This control lamp lights up when the main beams are on.

The warning lamp  is switched on once main beams are on or once the headlight flasher is operating.

For further information see \Rightarrow page 106.

Electro-hydraulic steering*

The level of steering assistance depends on the vehicle speed and on the steering wheel turning speed.

The control lamp should light up for a few seconds when the ignition is switched on. It should go out once the engine is started.

There is a fault in the electro-hydraulic steering system if the lamp does not go out or lights up whilst the vehicle is in motion. Take the vehicle to the Technical Service as soon as possible.



Note

When towing the vehicle with the engine stopped or due to a fault in the power steering, this will not operate. The vehicle can still be steered, but it will require greater force to turn the steering wheel.

Emission control system*

This warning lamp monitors the exhaust system.

Control lamp flashes:

When there is misfiring that can damage the catalytic converter. Reduce speed and drive carefully to the nearest specialised workshop to have the engine checked.

Control lamp is lit:

If a fault has developed during driving which has reduced the quality of the exhaust gas (e.g. lambda probe fault). Reduce speed and drive carefully to the nearest specialised workshop to have the engine checked.

Coolant level*/temperature

The warning lamp lights up if the coolant temperature is too high or if the coolant level is too low.

There is a fault if:

- The warning symbol does not go out again after a few seconds.
- The warning lamp lights up or flashes while the vehicle is moving, and **three acoustic warning signals** \Rightarrow  are emitted.

This means that either the coolant level is too low or the coolant temperature is too high.

Coolant temperature too high

If the warning light comes on, **stop the vehicle, switch off the engine and wait for it to cool down.** Check the coolant level.

If the coolant level is correct, the overheating may be caused by a malfunction of the radiator fan. Check the radiator fan fuse and have it replaced if necessary \Rightarrow page 231.

If the control lamp lights up again after driving on for a short distance, **stop the vehicle and switch the engine off**. Contact a Technical Service or a specialised workshop.

Coolant level too low

If the warning light comes on, **stop the vehicle, switch off the engine and wait for it to cool down** First check the coolant level. If the level of the coolant is below the "MIN" mark, top up with coolant liquid ⇒ .





WARNING

- If your vehicle is immobilised for technical reasons, move it to a safe distance from traffic. Turn the engine off, turn the hazard lights on and place the warning triangle.
- Never open the bonnet if you can see or hear steam or coolant escaping from the engine compartment. Risk of scalding. Wait until you can no longer see or hear escaping steam or coolant.
- The engine compartment is a dangerous area! Before carrying out any work in the engine compartment, switch off the engine and allow it to cool down. Always note the corresponding warnings ⇒ page 200.

Alternator

This warning lamp signals a fault in the alternator.

The warning lamp  lights up when the ignition is switched on. It should go out when the engine has started running.



If the warning lamp  lights up while driving, the alternator is no longer charging the battery. You should immediately drive to the nearest specialised workshop.

You should avoid using electrical equipment that is not absolutely necessary because this will drain the battery.

If the indicator flashes the voltage is insufficient for normal vehicle operation.

Turn signals

The control lamp flashes when the turn signals are in operation.

Depending on which turn signal is operated, either the left  or right  turn signal warning lamp flashes. Both control lamps will flash at the same time when the hazard warning lights are switched on.

If any of both turn signals fails, the warning lamp will start flashing twice faster than normal.

For further information on the turn signals, please see ⇒ page 106.

Electronic immobiliser "Safe"*

This warning lamp flashes if an unauthorised key is used.

Inside the key there is a chip that deactivates the electronic immobiliser automatically when the key is inserted into the ignition. The electronic immobiliser will be activated again automatically as soon as you pull the key out of the ignition lock.

The instrument panel displays the following message¹⁾: **SAFE**. The vehicle cannot be started in this case

¹⁾ Depending on the version of the model.

The engine can, however, be started if the appropriate coded SEAT genuine key is used.

**Note**

The vehicle cannot operate properly if you do not have a genuine SEAT key. ■

Steering column controls*

General information

The column incorporates multifunction modules from which to control audio and telephone functions on the vehicle.

There are two versions of the multifunction module:

- Audio version, to control the available audio functions from the steering wheel.
- Audio version+ Telephone version, to control the available audio functions and the telephone system from the steering wheel.

Both versions can be used to control the Audio system (Radio, Audio CD, MP3 CD, iPod¹⁾/USB¹⁾). ■

¹⁾ If fitted in the vehicle.

Audio Control

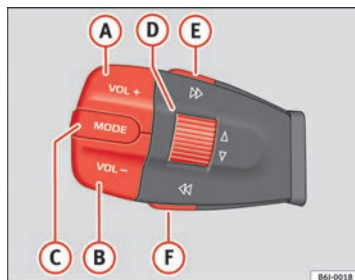

Fig. 41 Audio controls

Button	Short press			
	Radio	CD Audio	CD MP3	AUX-IN
A			Volume up	
B			Volume down	
C			Cycle through source FM - AM - CD - FM...	
D	Station search. Higher frequency △		Next track	No function
D	Station search. Lower frequency ▽		Previous track	No function
E	Next preset	No function	Change folder (forward)	No function
F	Previous preset	No function	Change folder (back)	No function

Audio + Telephone Control

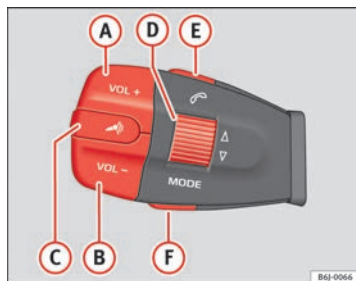

Fig. 42 Audio + Telephone Control

Button	Short press				Long press			
	Radio	CD	CD MP3/Micro SD/Bluetooth Audio	AUX-IN	Radio	CD	CD MP3/Micro SD/Bluetooth Audio	AUX-IN
A	Volume up				Continue volume up			
B	Volume down				Continue volume down			
C	Enable voice recognition. Press to speak With PID: No function specified				No function specified			
D	Station search. Higher frequency Δ	Next track	No function	No function	Station search. Higher frequency Δ	Next track	No function	No function
D	Station search. Lower frequency ▽	Previous track	No function	No function	Station search. Lower frequency ▽	Previous track	No function	No function ▶

E	Accept call/hang up ^{a)}	Reject call With PID: No function specified
F	Cycle through source FM - AM - CD - Micro SD - Bluetooth Audio - FM..	Cycle through source FM - AM - CD - Micro SD - Bluetooth Audio - FM..

^{a)} With PID the button, E, performs more functions. Consult the specific PID Navigator manual. ■

Opening and closing

Central locking

Description

The central locking system enables you to lock and unlock all doors by just pushing the button.

Central locking can be activated by using any of the following options:

- **the key**, by inserting it into the driver door cylinder and rotating it in the opening direction. Depending on the vehicle version, either all doors will be unlocked or only the driver door will be unlocked. All doors will be locked on locking the vehicle using the key.
- **the interior central lock button** ⇒ page 85.
- **the remote control**, using the buttons on the key ⇒ page 88.

Various functions are available to improve the vehicle safety:

- Safe* security system
- Selective unlocking system*
- Self-locking system to prevent involuntary unlocking
- Automatic speed-dependent locking and unlocking system*
- Emergency unlocking system



WARNING

- **Locking from the outside carelessly or without good visibility may lead to bruising, particularly in the case of children.**
- **When locking a vehicle, never leave children unaccompanied inside, as from the outside it will be difficult to provide assistance if required.**
- **Having the doors locked prevents an intrusion from getting in, for example when stopped at a traffic light.**



Note

For anti-theft security, only the driver door is fitted with a lock cylinder. ■

Safe security system*

This is an anti-theft device that consists of a double lock for the door locks and a disabling function for the luggage compartment in order to prevent a forced entry (depending on country).

Activation

The "safe" system is activated when the vehicle is locked using the key or the remote control.

To activate it with the key, rotate once it is inserted in the door lock cylinder in the locking direction.

To activate the system using the remote control, press the lock button once  on the remote. ▶

Once this system is activated, opening doors from the outside and the inside is not possible. The rear lid can not be opened. The central lock button does not work.

When the ignition is switched off, the instrument panel display indicates that the Safe system is on.

Deactivation

Rotate the key inserted in the lock cylinder twice towards the locking direction.

To activate the system using the remote control, press the lock button on the remote twice  in less than five seconds.

On deactivating the “Safe” system, the alarm volumetric sensor is also deactivated.

With the “Safe” switched off, doors can be opened from the interior but not from the exterior.

See “Selective unlocking system”

“Safe” status

On the driver door, there is a visible warning lamp which shows the “Safe” system status.

We will know that “Safe” system is activated by the flashing warning lamp. The indicator will flash on all vehicles, fitted and not fitted with an alarm, until they unlock.

Remember:

Safe activated with or without an alarm: Warning lamp flashes continuously.

Safe deactivated without an alarm: The indicator remains off.

Safe deactivated with an alarm: The indicator remains off.



WARNING

No one should remain inside the vehicle if the “Safe” mechanism is activated because opening the doors will not be possible in case of emergency neither from the inside nor the outside. Danger of death. Passengers could become trapped inside in case of emergency.

Selective unlocking system*

This system allows to unlock either just the driver door or all the vehicle.

Driver door unlock button

Unlock once. Use either the key or the remote control.

Once the key is inserted in the lock cylinder, rotate once in the unlock direction. The driver door will remain without “Safe” and unlocked. See Anti-theft Alarm chapter for vehicles fitted with an alarm → page 90.

Using the remote control, press the unlock button on the remote  once. The Safe system for all the vehicle is deactivated, only the driver door is unlocked and both the alarm and the warning lamp are also turned off.

Unlocking all doors and the luggage compartment

The unlock button on the remote control must be pressed twice  so that all doors and the luggage compartment can be opened.

Press twice within 5 seconds to deactivate the Safe system for all vehicle, to unlock all doors and to use the luggage compartment. The warning lamp and the alarm (only vehicles fitted with one) are turned off.

Unlocking the luggage compartment

See → page 93.

Activating the selective unlocking system*

With the door open, insert a key into the start cylinder and start the ignition. Insert the other key into the driver door lock and turn in the opening direction for at least 3 seconds. The turn signals will flash twice.

Deactivating the selective unlocking system*

With the door open, insert a key into the start cylinder and start the ignition. Insert the other key into the driver door lock and turn in the locking direction for at least 3 seconds. The turn signals will flash once.

Involuntary unlocking

It is an anti-theft system and prevents the unintentional unlocking of the vehicle.

If the vehicle is unlocked and any of the doors (including the rear lid) are opened within 30 seconds, it gets re-locked automatically.

Automatic speed dependent locking and unlocking system*

This is a safety system which prevent the access to the vehicle from the outside when it is running (for example, when stopped at a traffic light).

Locking

The doors lock automatically after exceeding 15 km/h (10 mph). The rear lid locks automatically after exceeding 6 km/h (4 mph).

If the vehicle is stopped and any of its doors open, when starting again and exceeding the mentioned speed, all doors will lock again.

Unlocking

On withdrawing the ignition key, the vehicle will returns to its status prior to self-locking.

Each door can be unlocked and opened independently from the inside (for example, when a passenger gets out of it). To do it, simply operate the lever inside the door.

Activating the system*

With the ignition on, press the locking key on the central locking system within 3 to 10 seconds.

Deactivating the system*

With the ignition on, press the unlocking key on the central locking system within 3 to 10 seconds.

In both cases, if the operation has been carried out correctly, the locking lamp will flash  => Fig. 43.

**WARNING**

The door handles must not be operated when the vehicle is running: the door would open.

**Note**

If the airbags are triggered during an accident, the vehicle is unlocked, except for the luggage compartment. It is possible to lock the vehicle from inside with the central locking, after turning the ignition off and back on again.

Emergency unlocking system

If the airbags are triggered during an accident, the vehicle is unlocked, except for the luggage compartment. It is possible to lock the vehicle from inside with the central locking, after turning the ignition off and back on again.

Central lock button*

The central lock button allows you to lock and unlock the vehicle from the inside.



Fig. 43 Central lock button

Locking the vehicle

- Press button  ⇒ Fig. 43 ⇒ .

Unlocking the doors

- Press the button  ⇒ Fig. 43.

The central lock button is still operative when the ignition is switched off. Except when the Safe security system is activated.



Please note the following if you lock your vehicle with the central lock button:

- Locking the doors and rear lid prevents access from the *outside* (for safety reasons, e.g. when stopped at a traffic light).
- The driver door cannot be locked. This avoids the user from forgetting his key inside the vehicle.
- All doors can be locked separately from inside the vehicle. Do this by pulling the door release lever *once*.

WARNING

- If the vehicle is locked, children and disabled people may be trapped inside it.
- Repeated operation of central locking will prevent the central lock button from working for a few seconds. Then, it can only be unlocked in case it has been previously locked. After few seconds, the central locking becomes operative again.
- The central lock button is not operative when the vehicle is locked from the outside (with the remote control or the key).

Note

- Vehicle locked,  button.
- Vehicle unlocked,  button.

Childproof lock

The childproof lock prevents the rear doors from being opened from the inside. This system prevents minors from opening a door accidentally while the vehicle is running.



Fig. 44 Childproof lock on the left hand side door

This function is independent of the vehicle electronic opening and locking systems. It only affects rear doors. It can only be activated and deactivated manually, as described below:

Activating the childproof lock

- Unlock the vehicle and open the door in which you wish to activate the childproof lock.
- With the door open, rotate the groove in the door using the ignition key, anticlockwise for the left hand side doors ⇒ **Fig. 44** and clockwise for the right hand side doors.

Deactivating the childproof lock

- Unlock the vehicle and open the door whose childproof lock you want to deactivate.
- With the door open, rotate the groove in the door using the ignition key, anticlockwise for the right hand side doors and clockwise for the left hand side doors ⇒ **Fig. 44**.

Once the childproof lock is activated, the door can only be opened from the outside. The childproof lock can be activated and deactivated by inserting the key in the groove when the door is open, as described above. ■

Keys

Set of keys

The set of keys includes a remote control, a key without a remote control and a plastic key tab*.

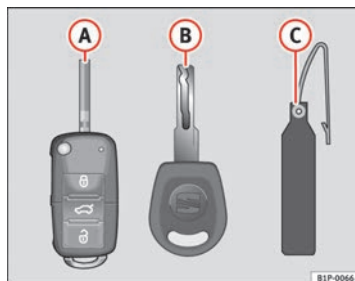

Fig. 45 Set of keys

The set of keys may consist of the following, depending on the version of your vehicle:

- a remote control key ⇒ Fig. 45 **A**
- a key without remote control **B**,
- a plastic key tab* **C**.

or

- two keys without remote control **B**
- a plastic key tab* **C**.

Duplicate keys

If you need a replacement key, go to a Technical Service with your vehicle identification number.

WARNING

- An incorrect use of the keys can cause serious injuries.
- Never leave children or disabled persons in the vehicle. In case of emergency, they may not be able to leave the vehicle or manage on their own.
- An uncontrolled use of the key could start the engine or activate any electric equipment (e.g. electric windows), causing risk of accident. The doors can be locked using the remote control key. This could become an obstacle for assistance in an emergency situation.
- Never forget the keys inside the vehicle. An unauthorised use of your vehicle could result in injury, damage or theft. Always take the key with you when you leave the vehicle.
- Never remove the key from the ignition if the vehicle is in motion. Otherwise, the steering could suddenly block and it would be impossible to steer the vehicle.

CAUTION

There are electronic components in the remote control key. Avoid wetting and hitting the keys. ■

Radio frequency remote control*

Locking and unlocking the vehicle

The radio frequency remote control key is used to lock and unlock the vehicle from a distance.

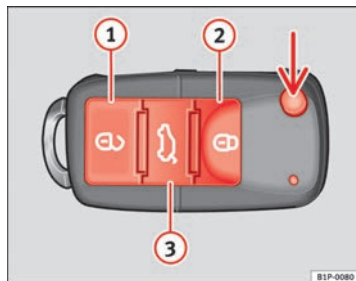

Fig. 46 Assignment of buttons on the remote control key

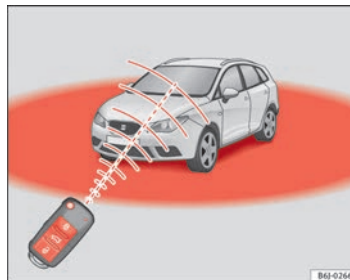

Fig. 47 Range of the radio frequency remote control

Using the button \Rightarrow Fig. 46 (arrow) on the control, the key blade is released.

Unlocking the vehicle \Rightarrow Fig. 46 ① .

Locking the vehicle \Rightarrow Fig. 46 ② .

Unlocking the rear lid. Press button \Rightarrow Fig. 46 ③ until all the turn signals on the vehicle flash briefly. When the unlocking button \Rightarrow Fig. 46 ③ is pressed, you have 2 minutes to open the door. Once this time has passed, it will lock again.

Also, the battery indicator on the key \Rightarrow Fig. 47, will flash.

The remote control transmitter and the batteries are integrated in the key. The receiver is inside the vehicle. The maximum range depends on different factors. The range is reduced as the batteries start to lose power. \blacktriangleright

**WARNING**

- An improper use of the key can cause serious injuries.
- Never leave children or disabled persons in the vehicle. In case of emergency, they may not be able to leave the vehicle or manage on their own.
- Never forget the keys inside the vehicle. Otherwise, this could result in serious injuries, accidents or even the theft of your vehicle. Always take the key with you when you leave the vehicle.
- An uncontrolled use of the key could start the engine or activate any electric equipment (e.g. electric windows), causing risk of accident. The vehicle can be locked when using the remote control key. This could complicate the aid in case of emergency.

**Note**

- The radio frequency remote control key functions only when you are within range ⇒ Fig. 47.
- If the vehicle cannot be unlocked or locked by using the radio frequency remote control, the remote control key will have to be re-synchronised. For this, go to your Technical Service.

Changing the battery

If the battery indicator does not flash when the buttons are pushed, the battery must be replaced.

**CAUTION**

The use of inappropriate batteries may damage the radio frequency remote control. For this reason, always replace the dead battery with another of the same size and power.

**For the sake of the environment**

Used batteries must be disposed of at an appropriate waste facility or through an authorised service, given that their components can affect the environment.

Synchronising the remote control key

If it is not possible to unlock or lock the door with the remote control, it should be re-synchronised.

While the vehicle is open:

- Press the  button ② ⇒ Fig. 46 on the remote control.
- Then close the vehicle using the key bit **within one minute**.

While the vehicle is closed:

- Press the  button ① ⇒ Fig. 46 on the remote control.
- Then close the vehicle using the key bit **within one minute**.

It is possible that the vehicle could no longer be opened and closed with the remote control if the button  is repeatedly pressed outside of the effective range of the radio frequency remote control. The remote control key will have to be resynchronised.

Spare remote control keys are available in your Technical Service, where they must be matched to the locking system.



Up to five remote control keys can be used.

Anti-theft alarm system*

Description of anti-theft alarm system*

The anti-theft alarm triggers if unauthorised movements are detected around the vehicle.

The anti-theft alarm makes it more difficult to break into the vehicle or steal it. The system will initiate acoustic and optical warning signals when your vehicle is tried to be forced.

The anti-theft alarm system is automatically switched on when locking the vehicle. For this, either rotate the key in the locking position or press button   on the radio frequency remote control*. The system is immediately activated and the turn signal light located on the driver door will flash along with the turn signals, indicating that the alarm and the locking security system (double lock) have been turned on.

If any of the doors or the bonnet are open, they will not be included in the protection zones of the vehicle when the alarm is connected. If the door or the bonnet are subsequently closed, they will be automatically included in the protection areas of the vehicle and the turn signals will flash accordingly when the doors close.

- The turn signal light will flash twice on opening and deactivating the alarm.
- The turn signal light will flash once on closing and activating the alarm.

When does the system trigger an alarm?

The system triggers an alarm if the following unauthorised actions are carried out when the vehicle is locked:

- Opening of vehicle with mechanical key without switching ignition on within the next 15 seconds
- Opening a door
- Opening the bonnet
- Opening the rear lid
- Ignition switched on with a non-validated key.
- Movements in the driving compartment (vehicles with a volume sensor)
- Towing of the vehicle¹⁾
- Tilt angle (tow-away protection)¹⁾
- Undue manipulation of the alarm
- Battery handling

The acoustic signals sound and the turn signals flash for approx. 30 seconds. This may be repeated up to 10 times depending on the country.

Opening all the doors in manual mode

In vehicles without alarm, when opening the driver door manually all the doors are opened.

How to switch the alarm off

To deactivate the anti-theft alarm, turn the key in the direction, to open, open the door and switch the ignition on, or press the unlock button  on the remote control.

In vehicles equipped with an anti-theft alarm system, you have 15 seconds to insert the key in the ignition lock and activate the ignition if the vehicle is opened using the driver door key.

Otherwise, the alarm will trigger for 30 sec. and the ignition will be blocked. ►

¹⁾ With vehicles fitted with a tow-away protection

**Note**

- After 28 days, the indicator light will be switched off to prevent the battery from exhausting if the vehicle has been left parked for a long period of time. The alarm system remains activated.
- The alarm will trigger again if attempts are made to open another protection zone.
- The alarm system can be activated or deactivated using the radio frequency remote control → page 88.



Vehicle interior monitoring and tow-away protection system*

Monitoring or control function incorporated in the anti-theft alarm which detects unauthorized vehicle entry by means of ultrasound.*

Activation

- It is automatically switched on when the anti-theft alarm is activated.

Deactivation

- Open the vehicle with the key, either mechanically¹⁾ or by pressing the  button on the remote control.
- Press the button  on the remote control twice. The volumetric sensor and tilt sensors will be deactivated. The alarm system remains activated.

¹⁾ The time period from when the door is opened until the key is inserted in the contact should not exceed 15 sec., otherwise the alarm will be triggered.

The vehicle interior monitoring and the tow-away protection system are automatically switched on again next time the vehicle is locked.

The vehicle interior monitoring and tow-away protection sensor (tilt sensor) are automatically switched on when the anti-theft alarm is switched on. In order to activate it, all the doors and the rear lid must be closed.

If you wish to switch off the vehicle interior monitoring and the tow-away protection system, it must be done each time that the vehicle is locked; if not, they will be automatically switched on.

The vehicle interior monitoring and the tow-away protection system should be switched off if animals are left inside the locked vehicle (otherwise, their movements will trigger the alarm) or when, for example, the vehicle is transported or has to be towed with only one axle on the ground.

False alarms

The interior monitoring only operates correctly if the vehicle is completely closed. Please observe legal requirements when doing so.

The following cases may cause a false alarm:

- opened windows (partially or fully)
- panoramic/tilting sunroof open (partially or completely).
- movement of objects inside the vehicle, such as loose papers, items hanging from the rear vision mirror (air fresheners), etc.

**Note**

- If the vehicle is relocked and the alarm is activated without the volumetric sensor function, relocking will activate the alarm with all its functions, except the volumetric sensor. This function is reactivated when the alarm is switched on again, unless it is deliberately switched off.
- If the alarm has been triggered by the volumetric sensor, this will be indicated by a flashing of the warning lamp on the driver door when the vehicle is opened. The flash is different to the flash indicating the alarm is activated.
- The vibration of a mobile phone left inside the vehicle may cause the vehicle interior monitoring alarm to trigger, as both sensors react to movements and shakes inside the vehicle.
- If on activating the alarm, any door or the rear lid is open, only the alarm will be activated. The vehicle interior monitoring and the tow-away protection system will only be activated once all the doors are closed (including the rear lid). ■

Rear lid

Unlocking and locking

The rear lid opening system operates electrically. It is activated by using the handle on the rear lid.

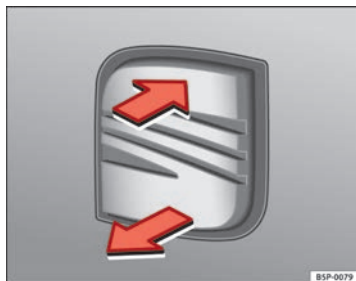

Fig. 48 Rear lid: opening from the outside

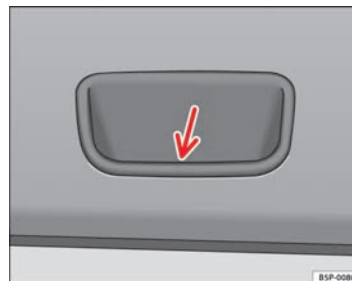

Fig. 49 Detail of the inside of the rear lid: hand grip

Opening the rear lid



- Pull on the release lever and lift the rear lid ⇒ Fig. 48. The rear lid will automatically open.

Closing the rear lid

- Hold the rear lid by one of the two handles on the interior lining and close it, pushing slightly.

The system may or may not operate depending on the situation of the vehicle.

If the rear lid is locked then it cannot be opened, however if it is unlocked then the opening system is operative and the rear lid may be opened.

To change the locking / unlocking status, press the button  or the button  ⇒ Fig. 46 on the remote control key.

A warning appears on the instrument panel display if the rear lid is open or not properly closed.* An audible warning is also given if the rear lid is opened while the vehicle is moving faster than 6 km/h (4 mph).* ▶

WARNING

- Always close the rear lid properly. Risk of accident or injury.
- The rear lid must not be opened when the reverse or rear fog lights are lit. This may damage the tail lights
- Do not close the rear lid by pushing it down with your hand on the rear window. The glass could smash. Risk of injury!
- Ensure the rear lid is locked after closing it. If not, it may open unexpectedly while driving.
- Never allow children to play in or around the vehicle. A locked vehicle can be subjected to extremely high and low temperatures, depending on the time of year, thus causing serious injuries/illness. It could even have fatal consequences. Close and lock both the rear lid and all the other doors when you are not using the vehicle.
- Closing the rear lid without observing and ensuring it is clear could cause serious injury to you and to third parties. Make sure that no one is in the path of the rear lid.
- Never drive with the rear lid open or half-closed, exhaust gases may penetrate into the interior of the vehicle. Danger of poisoning!
- If you only open the rear lid, do not leave the key inside. The vehicle will not be opened if the key is left inside.

Emergency opening

This allows the vehicle to be opened if the central locking does not operate (for example, if the battery is flat)

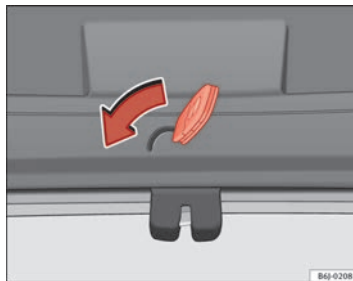

Fig. 50 Rear lid: emergency open

There is a groove in the luggage compartment allowing access to the emergency opening mechanism.

Opening the rear lid from inside the luggage compartment

- Insert the key in the groove and unlock the locking system, turning the key from right to left, as shown by the arrow ⇒ Fig. 50. ■

Windows

Opening or closing the windows electrically*

The front and rear electric windows can be operated by using the controls on the driver door. The other doors each have a switch for their own window.

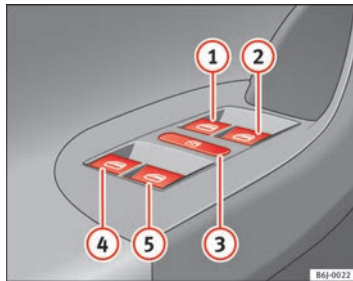





Fig. 51 Detail of the driver door: controls for the front and rear windows

Opening and closing the windows

- Press the button  to open the window.
- Pull button  to close the window ⇒ .

Always close the windows fully if you park the vehicle or leave it unattended ⇒ .

You can use the electric windows for approx. 10 minutes after switching off the ignition if neither the driver door nor the front passenger door has been opened and the key has not been removed from the ignition.

Buttons on the driver door

- ① Button for window in front left door
- ② Button for window in front right door
- ③ Safety switch for deactivating the electric window buttons in the rear doors
- ④ Button for window in rear left door
- ⑤ Button for window in rear right door

Safety switch

Safety switch ③ on the driver door can be used to disable the electric window buttons in the rear doors.

Safety switch not pressed: buttons on rear doors are activated.

Safety switch pressed: buttons on rear doors are deactivated.

WARNING

- Incorrect use of the electric windows can result in injury.
- Never close the rear lid without observing and ensuring it is clear, to do otherwise could cause serious injury to you and third parties. Make sure that no one is in the path of a window.
- Always take the vehicle key with you when you leave the vehicle.
- Never leave children or disabled persons in the vehicle, particularly if they have access to the keys. The misuse of the keys, for example, by children, may result in serious injury and accident.
- The engine may accidentally be started and be out of control.
- If the ignition is switched on, the electric equipment could be activated with risk of injury, for example, in the electric windows.
- The doors can be locked using the remote control key. This could become an obstacle for assistance in an emergency situation.
- Always take the key with you when you leave the vehicle.

 **WARNING (Continued)**

- The electric windows will work until the ignition has been switched off and one of the front doors has been opened.
- If necessary, use the safety switch to disable the rear electric windows. Make sure that they have been disabled.

**Note**

If the window is not able to close because it is stiff or because of an obstruction, the window will automatically open again ⇒ page 96. If this happens, check why the window could not be closed before attempting to close it again.

One-touch opening and closing*

One-touch opening and closing means you do not have to hold down the button.

Buttons ⇒ Fig. 51 ①, ②, ④ and ⑤ have two positions for opening windows and two for closing them. This makes it easier to open and close windows to the desired position.

One-touch closing

- Pull up the window button briefly up to the second position. The window closes fully.

One-touch opening

- Push down the window button briefly up to the second position. The window opens fully.

Restoring one-touch opening and closing

- The automatic open and close function will not work if the battery has been temporarily disconnected. The function can be re-stored as follows:
- Close the window as far as it will go by lifting and holding the electric window switch.
- Release the switch and then lift it again for one second. This will re-enable the automatic function.

- If you push (or pull) a button to the first stage, the window will open (or close) until you release the button. If you push or lift the button briefly to the second stage, the window will open (one-touch opening) or close (one-touch closing) automatically. If you operate the button while the window is opening or closing, it stops at this position.

The one-touch opening and closing function will not function once the ignition has been switched off.

The one-touch function and roll-back function will not work if there is a malfunction in the electric windows. Contact a specialised workshop. ■

Roll-back function

The roll-back function reduces the risk of injury when the electric windows close.

- If a window is obstructed when closing automatically, the window stops at this point and lowers immediately ⇒ .
- Next, check why the window does not close before attempting it again.
- If you try within the following 10 seconds and the window closes again with difficulty or there is an obstruction, the automatic closing will stop working for 10 seconds. ▶

- If the window is still obstructed, the window will stop at this point.
- If there is no obvious reason why the window cannot be closed, try to close it again by pulling the tab within ten seconds. The window closes with maximum force. **The roll-back function is now deactivated.**

If more than 10 seconds pass, the window will open fully when you operate one of the buttons. One-touch closing is reactivated.

The one-touch function and roll-back function will not work if there is a malfunction in the electric windows. Contact a specialised workshop.



WARNING

- **Incorrect use of the electric windows can result in injury.**
- **Always take the ignition key with you when leaving the vehicle, even if you only intend to be gone for a short time. Please ensure that children are never left alone inside the vehicle.**
- **The electric windows will work until the ignition has been switched off and one of the front doors has been opened.**
- **Closing the windows without observing and ensuring it is clear could cause serious injury to you and third parties. Make sure that no one is in the path of a window.**
- **Never allow people to remain in the vehicle when you close the vehicle from the outside. The windows cannot be opened even in an emergency.**
- **The roll-back function does not prevent fingers or other parts of the body from getting pinched against the window frame, causing injury.**

Convenience opening and closing*

Using the door lock*

- Hold the key in the door lock of the driver door in either the locking or the unlocking position until all windows are either opened or closed.
- Release the key to interrupt this function.

Using the remote control

- Keep the locking/unlocking button pressed for the electric window risers to open/close; if you stop pressing the button, the window raising/lowering function is stopped.
- If the automatic raising is stopped and immediately after, the opening button is kept pressed, the window risers will lower.
- Once the windows are completely closed, the turn signals will flash.

Panoramic tilting sunroof*

Opening and closing the panoramic/tilting sunroof

The panoramic/tilting sunroof is opened and closed by using the switch when the ignition is switched on.

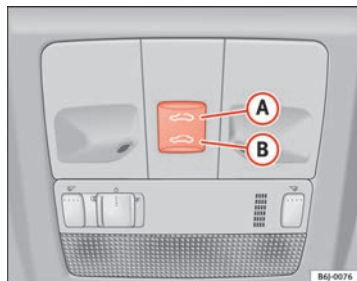

Fig. 52 Panoramic/tilting sunroof

Closing the panoramic/tilting sunroof

- Press and hold button **(B)** ⇒ Fig. 52 ⇒ ⚠. The roof starts to close until the button is released.

Opening the panoramic/tilting sunroof

- Press and hold down button **(A)**. The roof starts opening until the button is released.

Automatic closing of the panoramic/tilting sunroof

- Press button **(B)** once only; the sunroof starts closing automatically until it is completely closed.

Automatic opening of the panoramic/tilting sunroof

- Press button **(A)** once only. The sunroof starts opening automatically until it is completely open.

Restoring one-touch opening and closing

- Close the sunroof manually until it is completely closed. Release the button
- Press the closing button again, keeping it pressed down, until a complete opening and closing cycle has taken place.

Always close the panoramic/tilting sunroof fully if you park the vehicle or leave it unattended ⇒ ⚠.

The tilting sunroof can be operated for up to about ten minutes after the ignition has been switched off, provided the driver door and the front passenger door are not opened.

Sun visor

The sun visor is opened and closed manually (independently of the panoramic/tilting sunroof).

⚠ WARNING

- Incorrect use of the tilting sunroof can result in injury.
- Never close the tilting sunroof without first checking that there are no obstructions. Risk of serious injury to you or others. Make sure that no one is in the path of the tilting sunroof.
- Always take the vehicle key with you when you leave the vehicle.
- Never leave children or disabled persons in the vehicle, particularly if they have access to the keys. Unsupervised use of a key could mean that the engine is started or that electrical equipment is used (e.g. electric

⚠ WARNING (Continued)

tilting sunroof) with a risk of accident. The doors can be locked using the remote control key. This could become an obstacle for assistance in an emergency situation.

- The tilting sunroof continues to function until one of the front doors is opened and the key removed from the ignition.
- Ensure that no object and/or end is between the glass and the sunroof when the one-touch opening/closing function is reset.

Convenience closing*

Using the door lock

- Hold the key in the door lock of the driver door in the locking position until the tilting sunroof is closed.
- Release the key to interrupt this function.

Using the remote control

- Push the lock button on the remote control for about 3 seconds. The tilting sunroof closes.
- Press the unlock button to interrupt the function.

Roll-back function of the panoramic/tilting sunroof*

The panoramic/tilting sunroof has a *roll-back function* which prevents larger objects getting trapped when the roof is closed. The roll-back function does not prevent fingers getting pinched against the roof opening. The tilting sunroof stops and opens again immediately if it is obstructed when closing.

Operation in case of breakdown

In case of a breakdown, the sunroof may be closed manually.

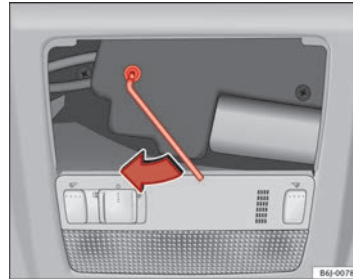

Fig. 53 Emergency operation of the panoramic/tilting sunroof

- Remove the plastic cover by inserting a screwdriver into the rear section.
- Insert an Allen key (4 mm) into the opening as far as possible and close the sunroof.

Lights and visibility

Lights

Switching lights on and off

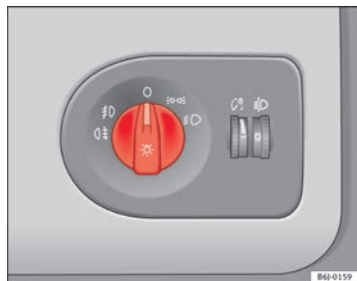

Fig. 54 Detailed view of the dash panel: lights, fog lights and rear fog light switch

Switching on the side lights

- Turn the light switch \Rightarrow Fig. 54 to position \Rightarrow .

Switching on dipped beam headlights

- Turn the light switch to position \Rightarrow .

Switching off the lights

- Turn the light switch to position 0.

Switching on the front fog lights*

- Turn the switch from position \Rightarrow or \Rightarrow to the first stop and pull it. The symbol \Rightarrow in the light switch lights up.

Switching on the rear fog light (vehicles with front fog lights)

- Turn the lights control from position \Rightarrow or \Rightarrow to the second stop and pull out \Rightarrow . A control lamp on the instrument panel lights up.

Switching on the rear fog light (vehicles with no front fog lights)

- Turn the light control to the end from position \Rightarrow or \Rightarrow and pull it. A control lamp on the instrument panel lights up.



WARNING

Never drive with just the side lights on. Risk of accident. The side lights are not bright enough to illuminate the road ahead and to ensure that other road users are able to see you. Always use your dipped beam headlights if it is dark or if visibility is poor.



Note

- The dipped beam headlights will only work with the ignition on. The side lights come on automatically when the ignition is turned off.
- If the lights are left on after the key has been taken out of the ignition lock, an audible warning sounds while the driver door remains open. This is a reminder to switch the lights off. \blacktriangleright

- The rear fog light is so bright that it can dazzle drivers behind you. You should use the rear fog light only when visibility is very poor.
- The use of the lighting described here is subject to the relevant statutory requirements.

Automatic lighting*



Fig. 55 Automatic lighting

Activation

- Rotate the switch to the position “Auto”, this indication will light up.

Deactivation

- Turn the light switch to 0.

Automatic lighting

If automatic headlight control is switched on, dipped beam headlights are automatically switched on by a photosensor if you drive into a tunnel, for example.

WARNING

- Even if the automatic headlight control is switched on, the dipped beam headlights will not be switched on with fog. Therefore, the dipped beam must be switched on manually.

Note

- For those vehicles with the automatic headlight system, when the key is removed from the ignition, the audible warning will only sound if the light knob is in position \Rightarrow or \Rightarrow .
- If the daylight driving automatic light function is switched on, the fog lights or rear fog light cannot be switched on in addition.
- The use of the lighting described here is subject to the relevant statutory requirements.
- Do not put stickers on the windscreen in front of the sensor. This may cause disruptions or faults in the automatic lighting system.
- The rain sensor switches on the dipped beam headlights when the windscreen wipers have been operating continuously for a few seconds and it switches the lights off when the continuous or interval wipe is switched off for some minutes.

Instrument and switch lighting / Headlight range control

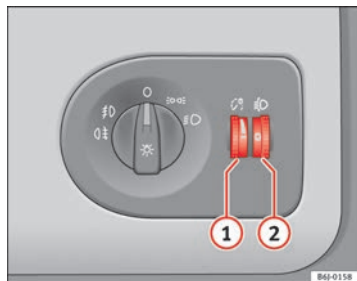

Fig. 56 Dash panel: regulation for instrument and switch lighting and headlight range control

Instrument and switch lighting ①

When the headlights are switched on, the brightness of the instruments and switch lighting can be regulated to suit your requirements by turning the thumb wheel ⇒ Fig. 56 ①.

Vehicles fitted with xenon gas discharge headlights are fitted with an automatic headlight range system.

The instrument lighting (some dials and needles), the centre console lighting and the lighting of the displays are regulated by a photodiode incorporated in the instrument panel.

The instrument lighting (needles) is switched on when the ignition is on and the **light is off**. The instrument lighting is dimmed automatically as the daylight starts to fade. It goes out completely when the ambient light level is very low. This function is intended to remind the driver to switch on the dipped beam headlights in good time when light conditions become poor.

Headlight range control ②

By using the electrical headlight range control, ② you can adjust the headlight range to the load level that is being carried in the vehicle. This way, it is possible to avoid dazzling oncoming traffic more than necessary. At the same time, by using the correct headlight settings, the driver has the best possible lighting for the road ahead.

The headlights can only be adjusted when the dipped beam is switched on. To lower the beam, turn the thumb wheel down ② from the basic setting 0.

Dynamic headlight range control

Vehicles with **gas discharge bulbs** (xenon bulbs) are equipped with **dynamic headlight range control**. When you switch on the lights, their range regulates itself according to the vehicle load.

Vehicles with gas discharge bulbs do not have headlight range control. ■

Daytime driving lights*

Daytime driving lights light up automatically when the ignition is switched on (only with AFS headlights)

Daylight driving lights switch off automatically when the side lights are switched on.

Activating daytime lights (bi-xenon lamps)

Remove the key from the ignition, move the turn signal lever upwards (right turn signal), press it backwards to flash position and hold in this position. Insert the key and switch the ignition on, holding it in this position for 3 seconds. Then, switch off the ignition. The daytime lights are activated and can be switched on.

Switching daytime lights off (bi-xenon lamps)

Remove the key from the ignition, move the turn signal lever upwards (left turn signal), press it backwards to flash position and hold in this position. ►

Insert the key and switch the ignition on, holding it in this position for 3 seconds. Then, switch off the ignition. The daytime lights are deactivated and cannot be switched on.

Note

See legal requirements for each country.

Adaptive headlights* (for driving round bends)

When driving around bends, the headlights will light the most important areas of the road.

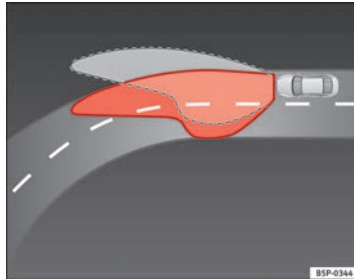

Fig. 57 Cornering lighting using adaptive headlights

This cornering light gives better illumination of the side of the road and the corner area. The dynamic lighting is controlled automatically according to speed and the steering wheel angle.

The two main headlights move at different angles to avoid that the front of the vehicle is left completely in the dark.

Note

The system operates from a speed of about 10 km/h (6 mph).

Fog lights with cornering function*

This is an additional light source to dipped beam headlights to light up the road as a bend is taken.

The cornering light operates with the lights switched on and when driving at less than 40 Km/h (25 mph). They light up when the steering wheel is turned or the flashers are operated.

Forward gear

- If the steering wheel is turned to the right, or the right-hand turn signal operated, the right-hand headlight lights up.
- If the steering wheel is turned to the left, or the left-hand flasher operated, the left-hand headlight lights up.

In reverse gear both headlights light up.

Note

When the fog lamps are on, the cornering function is activated and both headlights are continuously on.

Coming/leaving Home function*

The Coming Home function is controlled manually. The Leaving Home function is controlled with a photosensor.

If the Coming Home or Leaving Home function is connected, the front side and dipped lights, the tail lights and the number plate light will light up to provide assistance.

Coming home function

The Coming Home function is activated by switching off the ignition and briefly flashing the lights. When the driver door is opened, the Coming Home lighting comes on. If the driver door is already open when the lights are flashed briefly, the Coming Home lighting comes on **immediately**.

When the last door of the vehicle or the rear lid is closed, the Coming Home function starts and the switching off the headlights is delayed.

The Coming Home lighting switches off in the following cases:

- On completion of the time period established for the delay in switching off the lights after all the vehicle doors and the rear lid have been closed.
- If, 30 seconds after being connected, any doors or the rear lid remain open.
- If the light switch is turned to position 0.
- If the ignition is switched on.

Leaving home function

The Leaving Home function is activated when the vehicle is unlocked if:

- the light control is in position **AUTO** and
- the photosensor detects “darkness”.

The Leaving Home lighting switches off in the following cases:

- If the time period for the delay in switching off the headlights has ended
- If the vehicle is locked again.

- If the light switch is turned to position 0.
- If the ignition is switched on.



Note

- To activate the coming/leaving home function, the rotary light switch must be in position **AUTO** and the light sensor must detect darkness.
- If the ignition key is removed while the lights are on, and the lights are flashed briefly and the driver door opened, **no** audible warning is heard, as when the Coming Home function is on, the lights are automatically switched off after a period of time (except when the light switch is in position \gg or \ll).

Heated rear window



Fig. 58 Centre console: heated rear window switch

The heated rear window only works when the engine is running. When it is switched on, a lamp lights up on the switch.

After approx. 8 minutes, the heating device of the rear window switches off automatically.



For the sake of the environment

The heated rear window should be switched off as soon as the glass is demisted. By saving electrical power you can also save fuel.



Note

To avoid possible damage to the battery, an automatic temporary disconnection of this function is possible, coming back on when normal operating conditions are re-established.

Hazard warning lights

The hazard warning lights are used to draw the attention of other road users to your vehicle in emergencies.



Fig. 59 Dash panel: switch for hazard warning lights

If your vehicle breaks down:

1. Park your vehicle at a safe distance from moving traffic.
2. Press the button to switch on the hazard warning lights ⇒ .

3. Switch the ignition off.
4. Apply the handbrake.
5. On a manual gearbox engage 1st gear. On an automatic gearbox, move the selector lever to P.
6. Use the warning triangle to draw the attention of other road users to your vehicle.
7. Always take the vehicle key with you when you leave the vehicle.

Switch on the hazard warning lights to warn other road users, for example:

- reaching the tail end of a traffic jam,
- there is an emergency
- your vehicle breaks down due to a technical fault,
- you are towing another vehicle or your vehicle is being towed.

All turn signals flash simultaneously when the hazard warning lights are switched on. The two turn signal lamps ⇄ and the turn signal lamp in the switch  will flash at the same time. The hazard warning lights also work when the ignition is switched off.



WARNING

- The risk of an accident increases if your vehicle breaks down. Always use the hazard warning lights and a warning triangle to draw the attention of other road users to your stationary vehicle.
- Never park where the catalytic converter could come into contact with inflammable materials under the vehicle, for example dry grass or spilled petrol. This could start a fire!

**Note**

- The battery will run down if the hazard warning lights are left on for a long time, even if the ignition is switched off.
- The use of the hazard warning lights described here is subject to the relevant statutory requirements.

Turn signal and main beam headlight lever

The turn signal and main beam lever also operates the parking lights and the headlight flasher.

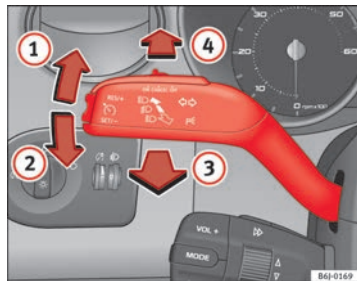

Fig. 60 Turn signal and main beam headlight lever

The turn signal and main beam headlight lever has the following functions:

Switching on the turn signals

- Move the lever all the way up ⇒ Fig. 60 ① to indicate **right**, and all the way down ② to indicate **left**.

Signalling a lane change

- Push the lever up ① or down ② to the point where you incur resistance and then release it. The turn signal will flash several times. The corresponding control lamp will also flash.

Switching main beam on and off

- Turn the light switch to position D .
- Press the lever forward ⇒ Fig. 60 ④ to switch on the main beams.
- Pull the lever back towards you to switch the main beam headlights off again.

Headlight flashers

- Pull the lever towards the steering wheel ③ to operate the flasher.







Switching on parking lights

- Switch the ignition off and remove the key from the lock.
- Move the turn signal lever up or down to turn the right or left-hand parking lights on, respectively.

**WARNING**

The main beam can dazzle other drivers. Risk of accident! Never use the main beam headlights or the headlight flasher if they could dazzle other drivers.

Note

- The *turn signals* only work when the ignition is switched on. The corresponding warning lamp  or  flashes in the instrument panel. The control lamp  flashes when the turn signals are operated, provided a trailer is correctly attached and connected to the vehicle. If a turn signal bulb is defective, the control lamp flashes at double speed. If the trailer turn signal bulbs are damaged, control lamp  does not light up. Change the bulb.
- The *main beam headlights* can only be switched on if the dipped beam headlights are already on. The warning lamp  then comes on in the instrument panel.
- The *headlight flasher* comes on for as long as you pull the lever – even if no other lights are switched on. The warning lamp  then comes on in the instrument panel.
- When the *parking lights* are switched on, the headlight and the tail light on the corresponding side of the vehicle light up. The parking lights will only work if the key is removed from the ignition. If the lights are switched on, an **audible warning** will be emitted while the driver door is open.
- If the turn signal lever is left on after the key has been taken out of the ignition lock, an acoustic signal sounds when the driver door is opened. This is a reminder to switch off the turn signal, unless of course you wish to leave the parking light on.

Interior lights

Front interior light

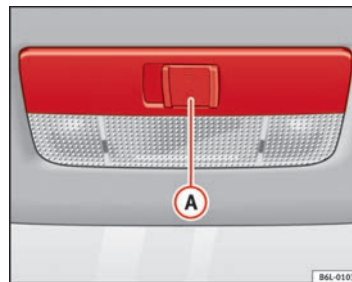



Fig. 61 Interior roof trim: front interior lighting

The switch  \Rightarrow Fig. 61 is used to select the following positions:



Courtesy light position

Sliding switch in central position The interior lighting is automatically switched on when the vehicle is unlocked or the key removed from the ignition. And turn off approx. 20 seconds after closing the doors. The interior lights are switched off when the vehicle is locked or when the ignition is switched on.

Interior light switched on

Move the knob to the position .

Interior light switched off

Move the switch to position  \Rightarrow Fig. 61. 

**Note**

If not all the vehicle doors are closed, the interior lights will be switched off after approx. 10 minutes, providing the ignition key has been removed and the courtesy light position selected. This prevents the battery from discharging.

Front reading light*

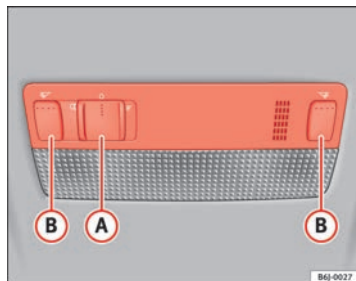

Fig. 62 Front reading light

Switching on the reading light

Press the corresponding button **(B)** → Fig. 62 to switch on the reading light.

Switching the reading lights off

Press the corresponding button to switch the reading light off.

Luggage compartment light*

The light is activated when the rear lid is open, even when the ignition and lights are turned off. For this reason, ensure that the rear lid is always closed.

Glove compartment light

When opening the glove compartment on the passenger side, the glove compartment light will automatically turn on and will turn off upon closure.

Visibility

Sun visors

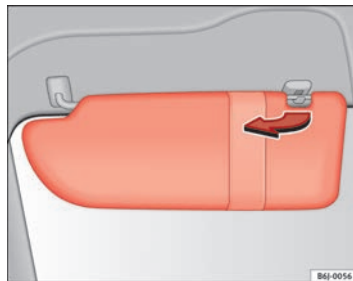

Fig. 63 Sun visor on the driver side

The sun visors for the driver and the front passenger can be pulled out of their central supports and turned towards the doors in the direction of the arrow → Fig. 63. Never pull them downwards.

The driver sun visor has compartments for cards, and the passenger sun visor has a vanity mirror with a cover*.

Note

Incorrect use of the sun visors (e.g. pulling them downwards once they are open) may result in broken hinges. This damage is not covered by the vehicle warranty.

Windscreen wipers

Front windscreen wipers

The window wiper lever controls the windscreen wipers and the automatic wash and wipe.

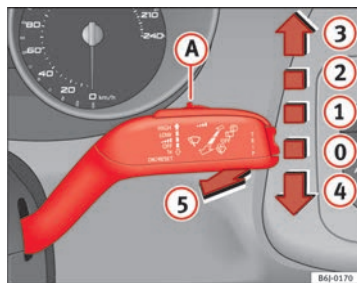

Fig. 64 Windscreen wiper and windscreen wash lever

The window wiper lever → Fig. 64 has the following positions:

Switching off the windscreen wipers

- Move the lever to position 0.

Interval wipe

- Move the lever up to position 1.
- Move the control A to the left or right to set the length of the wipe intervals. Control to the left: long intervals; control to the right: short intervals. Four wiper interval stages can be set using switch A.

Slow wipe

- Move the lever up to position 2.

Continuous wipe

- Move the lever up to position 3.

Short wipe

- Move the lever down to position 4 to give the windscreen a short wipe.

Wash and wipe automatic system

- Pull the lever towards the steering wheel - Position 5, the windscreen washer is activated.
- Release the lever. The wipers-washers will keep running for approximately four seconds.

WARNING

- **Worn and dirty wiper blades reduce visibility and safety levels while driving.**
- **In cold conditions, you should not use the wash/wipe system unless you have warmed the windscreen with the heating and ventilation system. The windscreen washer fluid could otherwise freeze on the windscreen and obscure your view of the road.**
- **Always note the corresponding warnings on ⇒ page 210.**

CAUTION

In icy conditions, always check that the wiper blades are not frozen to the glass before using the wipers for the first time. If you switch on the windscreen wipers when the wiper blades are frozen to the windscreen, you could damage both the wiper blades and the wiper motor.

Note

- The windscreen wipers will only work when the ignition is switched on.
- The heat output of the heated jets* is controlled automatically when the ignition is switched on, depending upon the outside temperature.
- In certain versions of vehicles with alarms, the windscreen wiper will only work in interval/rain sensor mode when the ignition is on and the bonnet closed.
- When the interval wipe function is on, the intervals are directly proportional to the speed. This way, the higher the vehicle speed the shorter the intervals.
- If you stop the vehicle with the windscreen wiper in position 1 or 2, it will automatically change to a lower speed. The set speed will be resumed when the vehicle pulls away.
- The windscreen will be wiped again after approximately five seconds once the “automatic wipe/wash system” has been operated, provided the vehicle is in transit (drip function). If you activate the wipers less than three

seconds after the drip function, a new wash sequence will begin without the last wipe. For the “drip” function to work again, you have to turn the ignition off and then on again. ■

Rain sensor*

The rain sensor controls the frequency of the windscreen wiper intervals, depending on the amount of rain.

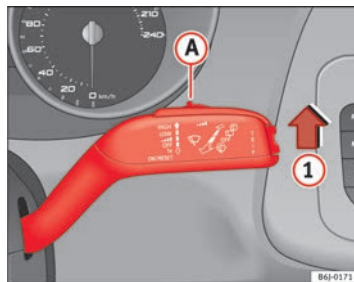

Fig. 65 Windscreen wiper lever

Switching on the rain sensor

- Move the windscreen wiper lever into position ① ⇒ Fig. 65.
- Move the control ① to the left or right to set the sensitivity of the rain sensor. Control to the right: highly sensitive. Control to the left: less sensitive.

The rain sensor is part of the interval wipe function. You will have to switch the rain sensor back on if you switch off the ignition. This is done by switching the interval wipe function off and back on. ►

Note

- Do not put stickers on the windscreen in front of the rain sensor. This may cause sensor disruption or faults.

Rear window wiper

The window wiper lever operates the windscreen wiper and the wash and wipe system for the rear window.

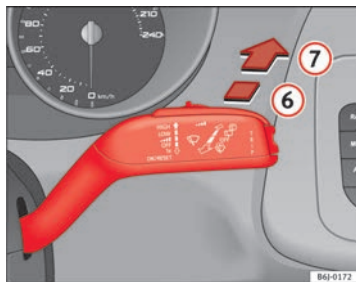

Fig. 66 Windscreen wiper and windscreen wash lever: rear window wiper

Switching on the interval wipe

- Press the lever forwards to position **6** ⇒ Fig. 66. The wiper will wipe the window approximately every 6 seconds.

Switching off the interval wipe function

- Pull the lever back from position **6** towards the steering wheel. The wiper will continue to function for a short period if you switch off whilst the wipers are in motion.

Switching on the windscreen wiper and washer system

- Press the lever fully forwards to position **7** ⇒ Fig. 66. The rear wiper and washer operate at the same time. The windscreen wash system will function as long as you hold the lever in this position.
- Release the lever. The washer system stops and the wipers continue until the end of the cycle.
- Move the lever towards the steering wheel to switch off.

WARNING

- A worn or dirty wiper blade will obstruct visibility and reduce safety.
- Always note the corresponding warnings on ⇒ page 210.

CAUTION

In icy conditions, always check that the wiper blade is not frozen to the glass before using the wiper for the first time. If you switch on the wiper when the wiper blade is frozen to the glass, this could damage both the wiper blade and the wiper motor.

Note

- The rear window wiper will only work when the ignition is switched on.
- Depending on the version of the model, when you engage reverse gear and with the headlight wiper activated, the lamps are wiped.

Headlight washer*

The headlight washers clean the headlight lenses.

The headlight washers are activated automatically when the windscreen washer is used and the window wiper lever is pulled towards the steering wheel for at least 1.5 seconds – provided the dipped beam headlights or main beams are switched on. Clean off stubborn dirt (insects, etc.) from the headlights at regular intervals, for instance when filling the fuel tank.



Note

- To ensure that the headlight washers work properly in winter, keep the nozzle holders in the bumper free of snow and remove any ice with a de-icer spray.
- To remove water, the windscreen wipers will be activated from time to time, the headlight washers will be activated every three cycles.

Rear view mirrors

Adjusting the rear view mirrors

Before beginning any journey, adjust the rear view mirrors for correct visibility.

Interior rear vision mirror

It is dangerous to drive if you cannot see clearly through the rear window.

Manual anti-dazzle function for interior rear vision mirror

In the basic mirror position, the lever at the bottom edge of the rear vision mirror should be at the front. Pull the lever to the back to select the anti-dazzle function.

Automatic anti-dazzle interior mirror*

The automatic anti-dazzle function can be switched on and off as desired.

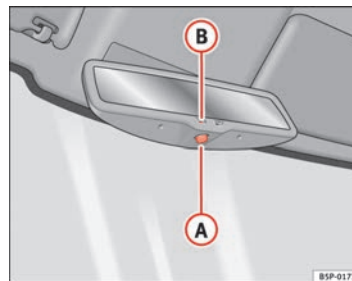

Fig. 67 Automatic anti-dazzle interior rear vision mirror.

Switching off the anti-dazzle function

- Press button **A** ⇒ Fig. 67. Control lamp **B** goes off.

Switching on the anti-dazzle function

- Press button **A** ⇒ Fig. 67. Control lamp is lit.

Anti-dazzle function

The anti-dazzle function is activated every time the ignition is switched on. The green indicator lamp lights up in the rear vision mirror housing.

When the anti-dazzle function is enabled, the interior rear vision mirror will darken **automatically** according to the amount of light it receives. The anti-dazzle function is cancelled if reverse gear is engaged.



Note

- The automatic anti-dazzle function will only work properly if the sun blind* for the rear window is retracted and there are no other objects preventing light from reaching the rear vision mirror.
- If you have to stick any type of sticker on the windscreen, do not do so in front of the sensors. Doing so could prevent the anti-dazzle function from working well or even from working at all.

Folding in the exterior mirrors

The exterior mirrors of the vehicle may be folded in. For this, press the mirror housing towards the vehicle.



Note

Before washing the vehicle with an automatic car wash, fold in the exterior mirrors to avoid damage.

Electric exterior mirrors*

The exterior mirrors can be adjusted using the rotary knob in the driver door.

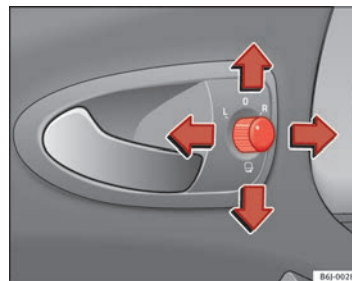

Fig. 68 Controls of exterior mirrors

Basic setting of exterior mirrors

1. Turn knob ⇒ Fig. 68 to position **L** (left exterior mirror).
2. Turn the rotary knob to position the exterior mirror so that you have a good view to the rear of the vehicle.
3. Turn knob to position **R** (right exterior mirror).
4. Swivel the rotary knob to position the exterior mirror so that you have a good view to the rear of the vehicle ⇒ **Δ**.

Heated exterior mirrors*

- Press the demisting button **☐** ⇒ Fig. 58

- The mirrors demist for some minutes to prevent draining the battery.
- If necessary, press the button again to repeat the function.
- The exterior mirror heating is not activated with temperatures above 20°C.

Folding in exterior mirrors*

- Turn the control ⇒ Fig. 68 to position  to fold in the exterior mirrors. You should always fold in the exterior mirrors if you are driving through an automatic car wash. This will help prevent damage.

Folding exterior mirrors back out to the extended position*

- Turn the knob to position L or R to fold the exterior mirrors back out ⇒ .



WARNING

- Convex or aspheric mirrors increase the field of vision however the objects appear smaller and further away in the mirrors. If you use these mirrors to estimate the distance to vehicles behind you when changing lane, you could make a mistake. Risk of accident.
- If possible, use the rear vision mirror to estimate distances to vehicles behind you.
- Make sure that you do not get your finger trapped between the mirror and the mirror base when folding back the mirrors. Risk of injury!



For the sake of the environment

The exterior mirror heating should be switched off when it is no longer needed. Otherwise, it is an unnecessary fuel waste.



Note

- If the electrical adjustment ever fails to operate, the mirrors can be adjusted by hand by lightly pressing the edge of the mirror glass.
- In vehicles with electric exterior mirrors, the following points should be observed: if, due to an external force (e.g. a knock while manoeuvring), the adjustment of the mirror housing is altered, the mirror will have to be completely folded **electrically**. Do not readjust the rear vision mirror housing by hand, as this will interfere with the mirror adjuster function.
- The rear view mirrors can be adjusted separately or simultaneously, as described before.
- The fold-in function on the exterior mirrors is not active at speeds over 40 km/h (25 mph).

Seats and storage compartments

The importance of correct seat adjustment

Proper seat adjustment optimises the level of protection offered by seat belts and airbags.

Your vehicle has **five** seats, two in the front and three in the rear. Each seat is equipped with a three-point seat belt.

The driver seat and the front passenger seat can be adjusted in many ways to suit the physical requirements of the vehicle occupants. The correct seat position is very important for:

- a fast and easy operation of all controls on the instrument panel,
- a relaxed posture which does not cause drowsiness,
- a safe driving ⇒ page 7,
- ensuring that the seat belts and airbag system provide maximum protection ⇒ page 19.

WARNING

- If the driver and passengers assume improper sitting positions, they may sustain critical injuries.
- Never transport more than the permitted amount of people in your vehicle.
- Every vehicle occupant must properly fasten and wear the seat belt belonging to his or her seat. Children must be protected with an appropriate child restraint system ⇒ page 43, Child safety.
- The front seats and all head restraints must always be adjusted to body size and the seat belt must always be properly adjusted to provide you and your passengers with optimum protection.

WARNING (Continued)

- Always keep your feet on the footwell when the vehicle is moving; never rest them on the dash panel, out of the window or on the seat. This is also applied to passengers. An incorrect sitting position exposes you to an increased risk of injury in case of a sudden braking or an accident. If the airbag is triggered, you could sustain severe injuries due to an incorrect sitting position.
- It is important for the driver and front passenger to keep a distance of at least 25 cm from the steering wheel and dash panel. Failure to respect the minimum distance means that the airbag will not protect you. Risk of fatal injury. The distance between the driver and the steering wheel or between the front passenger and the dash panel should always be as great as possible.
- Adjust the driver or front passenger seat only when the vehicle is stationary. Otherwise, your seat could move unexpectedly while the vehicle is moving. This could increase the risk of an accident and therefore, injury. In addition, while adjusting your seat, you will assume an incorrect sitting position. Risk of fatal accidents.
- Special guidelines apply to installing a child seat on the front passenger seat. When installing a child seat, please observe the warnings described in ⇒ page 43, Child safety.

Head restraints

Correct adjustment of head restraints

Properly adjusted head restraints are an important part of passenger protection and can reduce the risk of injuries in most accident situations.

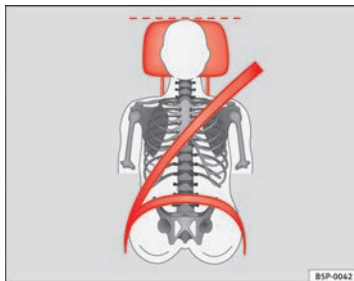

Fig. 69 Front view: head restraints and seat belts correctly adjusted

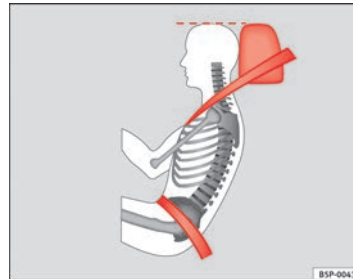

Fig. 70 Side view: head restraints and seat belts correctly adjusted

- Adjust the head restraint so that the top is at the same level as the top of your head or as close as possible to the same level as the top of your head, at least at eye level ⇒ Fig. 69 and ⇒ Fig. 70.

Adjusting the head restraints ⇒ page 117



WARNING

- Travelling with the head restraints removed or improperly adjusted increases the risk of severe injuries.
- Improperly adjusted head restraints could lead to death in the event of a collision or accident.
- Incorrectly adjusted head restraints also increase the risk of injury during sudden or unexpected driving or braking manoeuvres.
- The head restraints must always be adjusted according to the height of the passenger.

Removing or adjusting head restraints

The head restraints can be adjusted by moving them up and down.

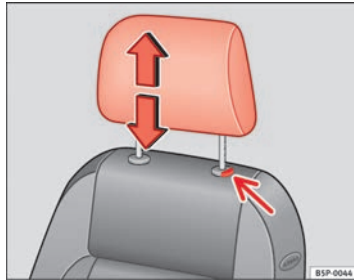

Fig. 71 Adjusting and removing the head restraints

Adjusting height (front seats)

- Press the button on the side and pull upwards to the desired position.
- To lower the head restraint, press the button and push head restraint downwards.
- Make sure that it engages securely into position.

Adjusting height (rear seats)

- Press the button on the side and pull upwards to the desired position.
- To lower the head restraint, press the button and push head restraint downwards.

- Make sure that the head restraint engages securely in one of its positions ⇒ page 14.

Removing the head restraint

- Push the head restraint up as far as it will go.
- Press the button ⇒ Fig. 71 (arrow).
- Pull head restraint out of fitting without releasing the button.

Fitting the head restraint

- Insert the head restraint into the guides on the backrest.
- Push head restraint down.
- Adjust the head restraint to suit body size ⇒ page 13.

WARNING

- Never drive if the head restraints have been removed. Risk of injury.
- Never drive if the head restraints are in an unsuitable position, there is a risk of serious injury.
- After refitting the head restraint, you must always adjust it properly for height to achieve optimal protection.
- Please observe the safety warnings in ⇒ page 116, Correct adjustment of head restraints.

Note

- To fit and remove the rear head restraints, gently tilt the seat backrest forwards.
- When fitting the head restraints again, insert the tubes as far as possible into the guides without pressing the button.

Front seats

Adjustment of the front seats



Fig. 72 Front left seat controls

① Adjusting the seat forwards and backwards

- Pull up the grip and move the seat forwards or backwards.
- Then release the grip ① and move the seat further until the catch engages.

② Adjusting seat height

- Pull the lever up or push down (several times if necessary) from its home position. This adjusts the seat height in stages.

③ Adjusting the backrest angle

- Take your weight off the backrest and turn the hand wheel.



WARNING

- Never adjust the driver or front passenger seat while the vehicle is in motion. While adjusting your seat, you will assume an incorrect sitting position. Risk of fatal accidents. Adjust the driver or front passenger seat only when the vehicle is stationary.
- To reduce the risk of injury to the driver and front passenger in case of a sudden braking or an accident, never drive with the backrest tilted towards the rear. The maximum protection of the seat belt can be achieved only when the backrests are in an upright position and the driver and front passenger have properly adjusted their seat belts. The further the seat backrests are tilted to the rear, the greater the risk of injury due to improper positioning of the belt web!
- Exercise caution when securing the seat height into forwards/backwards position. Injuries can be caused if the seat height is adjusted without due care and attention.
- To move the seat lengthways, pull upwards and not sideways on the lever, as the force exerted on it in this position could damage it.

Heated seats*

The front seat cushions and backrests can be heated electrically.



Fig. 73 Front seats heating switch

- Press the corresponding switch ⇒ Fig. 73 to switch on the seat heating.
- Press once to connect the heating at a maximum force. Two LEDs will light up ⇒ Fig. 73. After 15 min. of high intensity, the upper LED goes out, the system is deactivated for 2 min. and is then reactivated at low intensity (lower LED remains on permanently).
- Press the switch again to set the heating to minimum force. (The lower LED lights up).
- To disconnect the heating, press the switch again.

CAUTION

To avoid damaging the heating elements, please do not kneel on the seat or apply sharp pressure at a single point to the seat cushion and backrest.

Note

The seats are only heated electrically when the engine is running. ■

Rear seats

Folding down rear seats

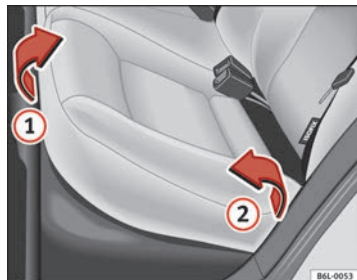

Fig. 74 Folding up the rear seat cushion

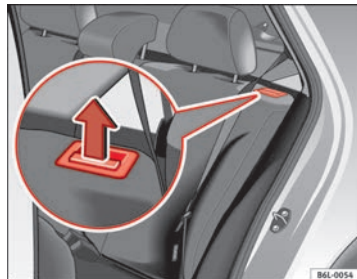

Fig. 75 Button for unlocking the rear backrest

Folding seat down

- Remove the head restraint ⇒ page 117.
- Pull the front edge of the seat cushion ⇒ Fig. 74 ① upwards in the direction of the arrow.
- Lift the cushion ② forwards in the direction of the arrow.
- Pull the release button ⇒ Fig. 75 in the direction of the arrow and fold the backrest forwards.
- Insert the head restraints in the spaces on the rear of the seat cushion which are visible when the seat cushion is lowered.

Folding seat forward

- Remove the head restraints from the spaces in the seat cushion.
- Lift the backrest, before securing it, replace the head restraints in the seat cushion, and then click the seat correctly onto the locking rails.
- Once the backrest is locked, pull on the central seat belt or directly on the backrest to check that the backrest has properly engaged in position.
- Check that the position lever is in neutral position.
- Lower the cushion and push it backwards below the seat belt buckles.
- Press the front part of the cushion downwards. ▶

On split rear seats¹⁾ the backrest and cushion can be lowered and raised respectively in two sections.

**WARNING**

- Please be careful when folding back the backrest! Injuries can be caused if the seat height is adjusted without due care and attention.
- Do no trap or damage seat belts when raising the backrest.
- After raising the backrest, check it has engaged properly in position. Do this by pulling on the central seat belt or directly on the backrest and check that the position lever is in the neutral position.
- The three point automatic seat belt only works correctly when the backrest of the central seat is correctly engaged.

¹⁾ Optional equipment

Storage compartment

Storage compartment on the front passenger side



Fig. 76 Passenger side: storage compartment

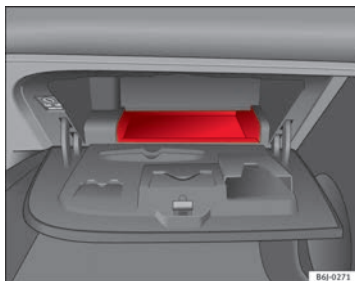

Fig. 77 Storage compartment for instruction manual

The compartment can be opened by pulling the lever ⇒ Fig. 76.

This compartment can hold documents in A4 format, a water bottle of 1.5 L,...



WARNING

Always keep the storage compartment cover closed while the vehicle is in motion in order to reduce the risk of injury caused by a sudden braking or by an accident.

Storage compartment on the driver side

There is a storage compartment on the driver side



Fig. 78 Driver side compartment

Navigator bracket on dash panel*

Your vehicle can be equipped with a portable navigator mounting bracket.

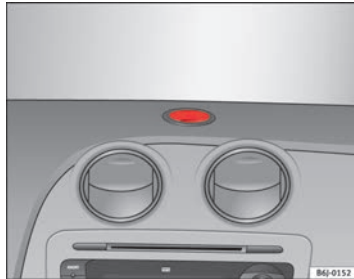

Fig. 79 Mounting bracket for navigator on dash panel.

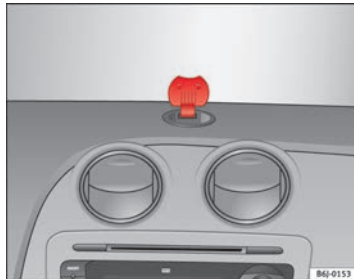

Fig. 80 Bracket with open cover for placing the navigator.

It is necessary to use a specific adapter for each navigator, so consult your Technical Service. This bracket supplies power to the portable navigator. ■

Storage compartment under front seats*



Fig. 81 Storage compartment under the front seat

To open

- The compartment is opened by pulling on the lever and assisting it with your hand.

To close

- Press the cover inwards until the closed drawer clicks into position.

Note

The storage drawer will hold a maximum weight of 1.5 kg. ■

Seat storage pocket*

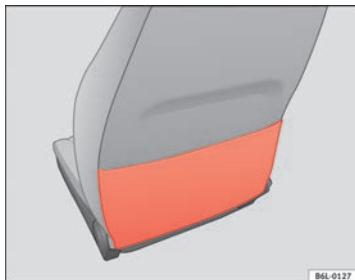

Fig. 82 Seat storage pocket

There is a storage pocket on the rear of the front seats.

Storage compartment in the front door panel*

In this storage compartment a 1.5l water bottle can be stored,...

Front drink holder*



Fig. 83 Front drink holders in the centre console

- There are two cup holders in the centre console in front of the gearbox lever ⇒ Fig. 83.



WARNING

- Do not put hot drinks in the drink holders. During normal or sudden driving manoeuvres, sudden braking or an accident, the hot drink could be spilled. Danger of scalding.
- Never use rigid materials (for example, glass or ceramic), these could cause injury in the case of an accident.
- When travelling the drink holder should always be closed to prevent risk in the event of sudden braking or accident.

Rear drink holder*

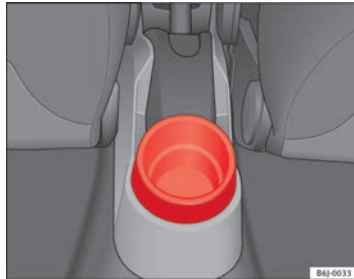

Fig. 84 Drink holder in the centre console

On the rear part of the centre console, behind the handbrake, there is a drink holder installed* ⇒ Fig. 84.

This drink holder has a capacity of a bottle of up to 1 litre.

Ashtrays, cigarette lighter and power socket

Ashtray*



Fig. 85 Ashtray

Opening and closing the ashtray

- To open the ashtray, lift the cover ⇒ Fig. 85.
- To close, push the cover down.

Emptying the ashtray

- Extract the ashtray and empty it.

WARNING

Never put paper in the ashtray. Hot ash could ignite the paper in the ashtray and cause a fire.

Cigarette lighter*



Fig. 86 Lighter

- Press on the cigarette lighter ⇒ Fig. 86 to activate it ⇒ ⚠.
- Wait for the lighter to pop out slightly.
- Pull out the cigarette lighter and light the cigarette on the glowing coil.

⚠ WARNING

- Improper use of the cigarette lighter can lead to serious injuries or start a fire.
- Using the lighter carefully. Carelessness or negligence when using the cigarette lighter can cause burns, risk of injury.
- The lighter only works when the ignition is turned on or the engine is running. To avoid the risk of fire, never leave children alone inside the vehicle.

Power socket



Fig. 87 Front power socket

The 12 Volt cigarette lighter power socket can also be used for other electrical components with a power rating of up to 120 Watt. When the engine is switched off, however, the vehicle battery will discharge. For further information see ⇒ page 190.

⚠ WARNING

The power sockets and the connected accessories will only operate when the ignition is on or when the engine is running. Improper use of the sockets or electrical accessories can lead to serious injuries or cause a fire. To avoid the risk of injury, never leave children alone inside the vehicle.



Note

- The use of electrical appliances with the engine switched off will cause a battery discharge.
- Before using any electrical accessories, see the instructions in ⇒ page 190.

Power socket in the luggage compartment*

Electrical equipment can be connected to the 12 volt power socket.

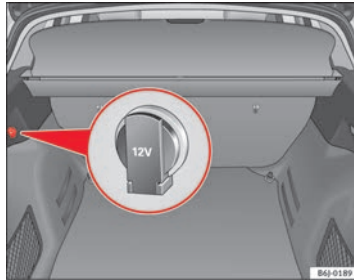

Fig. 88 Detailed view of the side trim in the luggage compartment: 12 volt power socket

- Lift the power socket cover ⇒ Fig. 88.
- Insert the plug of the electrical appliance into the power socket.

Electrical equipment can be connected to the 12 volt power socket. The appliances connected to the power socket must not exceed a power rating of 100 W.



CAUTION

Always use the correct type of plugs to avoid damaging the sockets.



Note

- The power sockets will only work with the ignition on.
- The use of electrical appliances with the engine switched off will cause a battery discharge.

Auxiliary audio input connection (AUX)*



Fig. 89 AUX connection on the central console (depending on the equipment)

- Insert the plug as far as possible (see radio manual) ⇒ Fig. 89. ■

AUX/USB input connection*

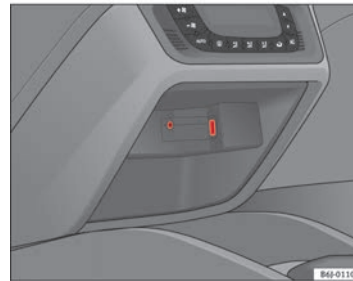

Fig. 90 AUX/USB* input connection (depending on the equipment) ▶

For information concerning the use of this equipment, please see the Radio handbook.

First-aid kit, warning triangle, fire extinguisher

Warning triangle*

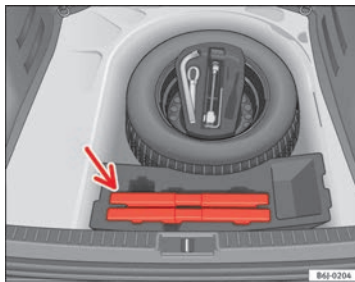

Fig. 91 Housing for the emergency warning triangle in the luggage compartment.

The warning triangle is under the storage compartment which is located under the luggage compartment floor.

i Note

- The warning triangle is not part of the vehicle's standard equipment. ■

First-aid kit and fire extinguisher*

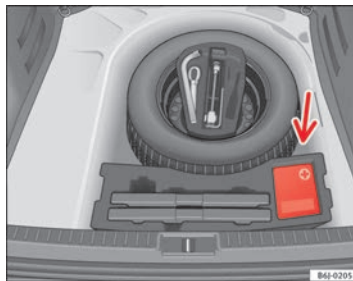

Fig. 92 Housing for the first-aid kit in the luggage compartment.

The first-aid kit can go in the storage compartment which is located under the luggage compartment floor.

The fire extinguisher* is attached to the luggage compartment carpet with Velcro.

i Note

- The first-aid kit and the fire extinguisher are **not** part of the vehicle's standard equipment.
- The first aid kit must comply with legal requirements.
- Observe the expiry date of the contents of the first aid kit. After it has expired you should purchase a new one.
- The fire extinguisher must comply with legal requirements.
- Ensure that the fire extinguisher is fully functional. The fire extinguisher should, therefore, be checked regularly. The sticker on the fire extinguisher will inform you of the next date for checking.
- Before acquiring accessories and emergency equipment see the instructions in "Accessories and spares" → page 190. ■

Luggage compartment

Loading the luggage compartment

Loads in the luggage compartment should be safely secured.

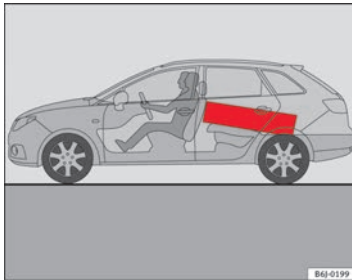

Fig. 93 Position heavy items as far forward as possible.

To maintain safe handling on the road, please observe the following points:

- Distribute the load evenly.
- Position heavy items as far forward as possible ⇒ Fig. 93.
- Secure the load with a luggage net* or with non-elastic straps secured to the fastening rings ⇒ page 130.

WARNING

- Unsecured objects in the luggage compartment can suddenly shift and cause changes in the handling of the vehicle.
- In an accident or a sudden manoeuvre, loose objects in the passenger compartment can be flung forward and might injure vehicle occupants.
- Always keep all objects in the luggage compartment and use appropriate grips to secure them, particularly in the case of heavy objects.
- When you transport heavy objects, always bear in mind that a change of the centre of gravity can also cause changes in vehicle handling.
- Please refer to the notes on ⇒ page 7.

CAUTION

Make sure that no hard objects chafe against the wires of the heating element in the rear window and damage them.

Note

The tyre pressure must be adjusted according to the load. When necessary check the tyre pressures on the label located on the inside fuel tank flap ⇒ page 217.

Fastening rings*

There are four fastening rings in the luggage compartment, which can be used to secure loads.

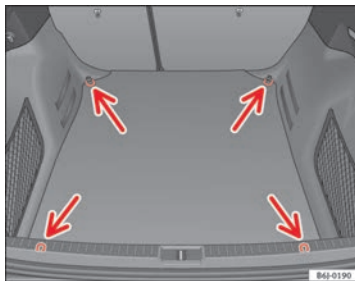

Fig. 94 Location of fastening rings in luggage compartment

- Use the fastening rings to secure the load ⇒ Fig. 94 -arrows-
- Please refer to the safety notes ⇒ page 17.

Luggage net*

The luggage net can be used to secure and retain light items in the luggage compartment.

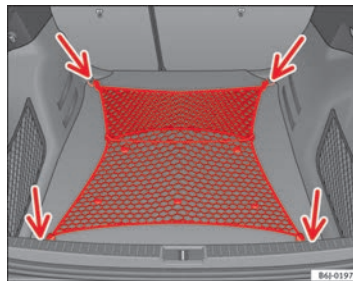

Fig. 95 Stretched luggage net

Luggage net

- Secure the luggage net to the four fastening rings -arrows- ⇒ Fig. 95.

The luggage net can be attached to the fastening rings in the bottom of the luggage compartment panel.

WARNING

The luggage net should only be used to hold objects weighing up to 5 kg. Heavier objects cannot be safely secured (risk of injury).

Rear shelf

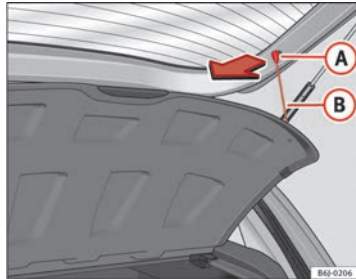

Fig. 96 Rear shelf

Removing the shelf

- Unhook the loops ⇒ Fig. 96 B from housings A.
- With the half open position, pull the shelf upwards.

WARNING

Do not place heavy or hard objects on the rear shelf, because they will endanger the vehicle occupants in case of sudden braking.

CAUTION

- Before closing the rear lid, ensure that the rear shelf is correctly fitted.
- An overloaded luggage compartment could mean that the rear shelf is not correctly seated and it may be bent or damaged.
- If the luggage compartment is overloaded, remove the tray.

Note

- Ensure that, when placing items of clothing on the luggage compartment cover, rear visibility is not reduced.

Rear shelf with storage compartment*



Fig. 97 Removing storage compartment

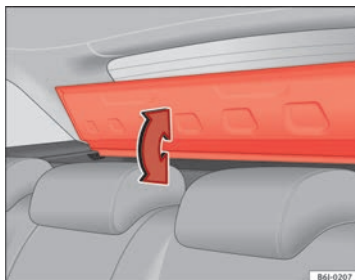

Fig. 98 Accessing storage compartment

To remove the storage compartment

- Remove the rear shelf and pull the storage compartment upwards holding it by the edges ⇒ Fig. 97.

The storage compartment can be accessed from the rear seats by lifting the front side of the rear shelf ⇒ Fig. 98.



WARNING

Do not place heavy or hard objects on the rear shelf, because they will endanger the vehicle occupants in case of sudden braking.



CAUTION

- Before closing the rear lid, ensure that the rear shelf is correctly fitted.
- An overloaded luggage compartment could mean that the rear shelf is not correctly seated and it may be bent or damaged.
- If the luggage compartment is overloaded, remove the tray.
- The load in the storage compartment should not exceed 3 kg.



Note

- Ensure that, when placing items of clothing on the luggage compartment cover, rear visibility is not reduced.
- If your vehicle has a storage compartment*, only place light objects inside.

Roof rack*

Please observe the following points if you intend to carry loads on the roof:

- For safety reasons, only luggage racks and accessories supplied by SEAT Official Services should be used. ▶

- It is essential that you follow the assembly instructions included with the bars exactly, being especially careful to position the front and rear luggage compartment cover bars on the special housings on the longitudinal bars. You must also respect their position according to the direction of travel indicated in the assembly manual. Not following these instructions may cause marks on the longitudinal bars.
- Distribute the load evenly. A maximum load of 40 kg only is permitted for each roof rack system support bar, the load must be distributed evenly along the entire length. However, the maximum load permitted for the entire roof (including the support system) of 75 kg must not be exceeded nor should the total weight of the vehicle be exceeded. See the Technical Data section.
- When transporting heavy or large objects on the roof, any change in the normal vehicle behaviour due to a change in the centre of gravity or an increased wind resistance must be taken into account. For this reason, a suitable speed and driving style must be used.
- For those vehicles fitted with a sliding/tilting sunroof*, ensure that it does not interfere with the load on the roof rack system when opened. ■

Air conditioning

Heating

Controls

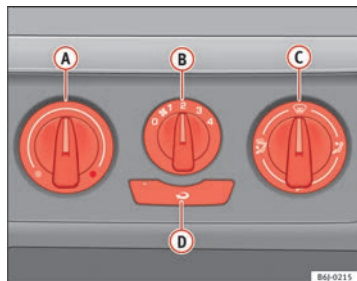

Fig. 99 Heating controls on the dash panel

- Using the controls **(A)** and **(C)** and with the switch **(B)** ⇒ Fig. 99 you can adjust the temperature, the air distribution and the blower speed.
- Press the button **(D)** to switch air recirculation mode on or off. When the function is activated, a warning light on the button is turned on.

Temperature

Switch **(A)** adjusts temperature. The required temperature inside the vehicle cannot be lower than the ambient temperature. Maximum heat output,

which is needed to defrost the windows quickly, is only available when the engine has reached its operating temperature.

Blower

The air flow can be set at four speeds with switch **(B)**. The blower should always be set at the lowest speed when driving slowly.

Air distribution

Control **(C)** for setting the flow of air in the required direction.

☞ – Air distribution towards the windscreen in order to demist. For safety reasons, **it is not recommended** to switch air recirculation on.

☞ – Air distribution to the upper body

☞ – Air distribution to footwell

☞ – Air distribution to the windscreen and the footwell.

Air recirculation mode ⇄

Air recirculation mode **(D)** on (a lamp lights up in red) prevents strong odours from the outside air from entering in the vehicle, for example when passing through a tunnel or in a traffic jam ⇒ ⚠.

When the outside temperature is low, air recirculation mode improves heating performance by heating air from the interior instead of cold air from the outside. ▶

WARNING

- For your safety, the windows should never be fogged up or covered with snow or ice. This is essential to ensure good visibility. Please familiarise yourself with the correct operation of the heating and ventilation system, including the demist/defrost functions for the windows.
- In air recirculation mode, no cold air from the outside enters the vehicle interior. The windows can quickly fog over if the heating is switched off. Therefore, never leave the air recirculation mode switched on for a long time (risk of accident).

Note

- Please consider the general notes ⇒ page 142.

Vehicle ventilation or heating

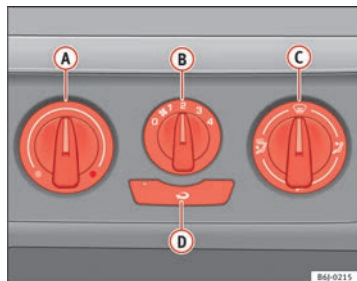

Fig. 100 Heating controls on the dash panel

Ventilating the vehicle interior

- Turn the temperature selector **(A)** ⇒ Fig. 100 anticlockwise.
- Turn blower switch **(B)** to any of the head settings 1 -4.
- Set the airflow to the desired direction using air distribution control **(C)**.
- Open the relevant air outlets.

Interior heating

- Turn the temperature selector **(A)** ⇒ Fig. 100 clockwise to select the desired temperature.
- Turn blower switch **(B)** to any of the head settings 1 -4.
- Set the airflow to the desired direction using air distribution control **(C)**.
- Open the relevant air outlets.

Defrosting the windscreen

- Turn the temperature selector **(A)** ⇒ Fig. 100 clockwise to reach the maximum temperature.
- Turn the blower switch **(B)** to setting 4.
- Turn air distribution control to .
- Close outlet **(3)**.
- Open and turn outlet **(4)** towards side windows

Keeping the windscreen and the side windows demisted

- Turn the temperature selector **(A)** ⇒ Fig. 100 to the heating area. ▶

- Turn blower switch **(B)** to any of the head settings 2 -3.
- Turn air distribution control to .
- Close outlets **(3)**
- Open and turn outlets **(4)** towards side windows.

Once the windows are demisted and as a preventive measure, the control **(C)** can be set in position , thus obtaining greater comfort while preventing the windows from misting again.

Heating

Maximum heat output, which is needed to defrost the windows quickly, is only available when the engine has reached its operating temperature.



Note





Remember that the temperature of the engine coolant should be optimum to ensure that the heating system functions correctly (except in vehicles fitted with additional heating*)

Air outlets



Fig. 101 Air vents

Air distribution **C**

Switch on symbol	Main air output through outlets:
	1,2
	5
	1, 2, 5
	3, 4

Outlets **3** and **4** can be closed or opened separately and the air flow directed as required.

Air conditioning*

Controls

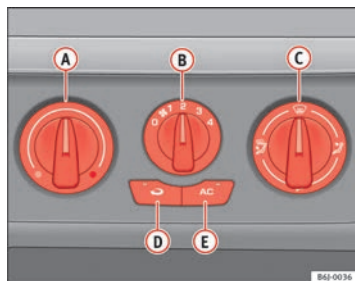



Fig. 102 Air conditioning controls on the dash panel

The air conditioning system only works when the engine is running and the fan is switched on.

- Using the controls ⇒ Fig. 102 **A** and **C** and with the switch **B** you can adjust the temperature, the air distribution and the blower speed.
- To switch a function on or off, press the appropriate button **D** or **E**. When the function is activated, a red warning light on the button is turned on.
- **To demist the windscreen:**
 - Turn air distribution to .
 - Turn the fan control to one of the two levels depending on the speed required.
 - Rotate the temperature control to the desired level of comfort.
 - Close outlets **3**
 - Open and turn outlets **4** towards side windows.

A Temperature selector ⇒ page 138

B Blower control. There are four speed settings for the blower. At low speed, it is recommended to set the blower to a minimum of 1 to improve the intake of fresh air.

C Air distribution control ⇒ page 138

D Air recirculation button  ⇒ page 139

E  button – Switch on air conditioning ⇒ page 138

⚠ WARNING

For your safety, the windows should never be fogged up or covered with snow or ice. This is essential to ensure good visibility. Please familiarise yourself with the correct operation of the heating and ventilation system, including the demist/defrost functions for the windows.



Note

Please consider the general notes.

Vehicle interior heating or cooling system

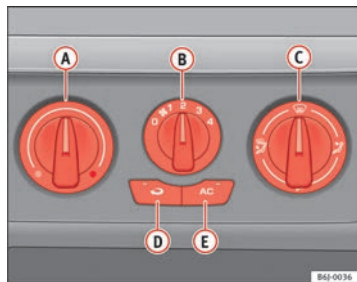

Fig. 103 Air conditioning controls on the dash panel

Interior heating

- Disconnect the cooling system using button ⇒ Fig. 103 **AC** (the button light turns off).
- Turn the temperature selector **A** to set the desired temperature inside the vehicle.

- Turn the blower switch to any of the settings 1-4.
- Set the air distribution control **C** to the air flow configuration desired: **1** (towards the windscreen), **2** (towards the chest), **3** (towards the footwell) and **4** (towards the windscreen and footwell areas).

Interior cooling

- Connect the cooling system with button **AC** (the button light *should* light up).
- Turn the temperature control switch until the desired interior temperature is reached.
- Turn the blower switch to any of the settings 1-4.
- Set the air distribution control to the air flow configuration desired: **1** (towards the windscreen), **2** (towards the chest), **3** (towards the footwell) and **4** (towards the windscreen and footwell areas).

Heating

Maximum heat output, which is needed to defrost the windows quickly, is only available when the engine has reached its operating temperature.

Coolant system

When the air conditioning is switched on, the temperature and the air humidity go down. This way, if the outside humidity is extreme, the air conditioning prevents the misting of the windows and therefore, comfort is improved.

If the air conditioning does not work, this may be due to the following reasons:

- The engine is stationary.
- The fan blower is switched off.

- The outside temperature is below +3°C.
- The air conditioning system compressor has been temporarily switched off because of an increased engine coolant temperature.
- The air conditioner fuse is faulty.
- Another fault in the vehicle. Have the air conditioning checked by a specialised workshop.

Air recirculation

Air recirculation mode prevents fumes or unpleasant smells from coming from the outside.

When air recirculation mode is switched on (button \Rightarrow Fig. 103  with warning lamp) strong odours in the outside air do not enter the vehicle interior, for example when passing through a tunnel or in a traffic jam.

When the outside temperature is low, air recirculation mode improves heating performance by heating air from the interior instead of cold air from the outside.

When the outside temperature is high, air recirculation mode improves cooling performance by cooling air from the interior instead of warm air from outside.

For safety reasons, the air recirculation **should not be switched on** when the air distribution control is set to the windscreen setting .





WARNING

In air recirculation mode, no cold air from the outside enters the vehicle interior. If the air conditioner is switched off, the windows can quickly mist over. Therefore, never leave the air recirculation mode switched on for a long time (risk of accident).



Note

- When engaging reverse gear, the air recirculation is connected automatically to prevent the entrance of exhaust gases in the vehicle on travelling backwards. The control lamp on the button  does not light up.
- If the temperature control is turned to the coldest setting (blue point) and the switch  is activated, the "Air recirculation" function is automatically activated in order to cool the vehicle rapidly using less energy; its function control lamp will light.
- If the function is not deactivated by pressing the button, this will deactivate after approx. 20 min.

Economic use of the air conditioning

When the air conditioning is switched on, the compressor consumes engine power and has influence on fuel consumption. Consider the following points in order to have the system operating in the minimum possible time.

- If the vehicle interior has overheated due to an excessive solar radiation, it is best to open the windows or doors to allow the hot air to escape.
- While in motion, the air conditioning should not be switched on if the windows or the sunroof are open.*

Climatronic

Controls

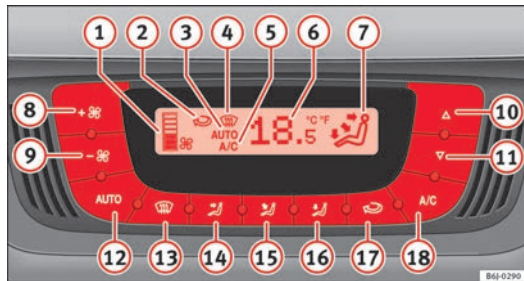

Fig. 104 Climatronic controls on the dash panel

The air conditioner only works when the engine is running and the blower is switched on.

- Press keys **10** and **11** ⇒ Fig. 104 to adjust temperature.
- The functions will be switched on when its buttons are pressed. When the function is activated, a symbol is displayed on the screen. Press the button again to switch off the function.

- 1 Blower level indicator.
- 2 Air recirculation display:
- 3 Display **AUTO** (Automatic operation)
- 4 Demisting indicator
- 5 AC indicator (Cooling connected)

- 6 Interior temperature indicator selected
- 7 Air flow direction indicator
- 8 Fan speed increase
- 9 Fan speed decrease
- 10 Interior temperature increase
- 11 Interior temperature decrease
- 12 **AUTO** button – Automatic adjustment of temperature, ventilation and air distribution
- 13 Button – Windscreen demisting function. The air drawn in is directed at the windscreen. The air recirculation mode will be switched off as soon as the demisting function is switched on. At temperatures over 3°C, the cooling system is switched on automatically in order to dry the air.
- 14 Button – Air distribution to head area
- 15 Button – Air distribution to the upper body
- 16 Button – Air distribution to footwell
- 17 – Manual air recirculation
- 18 **AC** button – To switch on the air conditioning.

WARNING

For your safety, the windows should never be fogged up or covered with snow or ice. This is essential to ensure good visibility. Please familiarise yourself with the correct operation of the heating and ventilation system, including the demist/defrost functions for the windows.

Note

Please consider the general notes.

Automatic mode

In automatic mode air temperature, air flow and distribution are automatically regulated so that a specified temperature is attained as quickly as possible, and then maintained.

Switching on automatic mode

- Press the button **AUTO**. The indication \Rightarrow Fig. 104 **3** is displayed.
- Press keys **10** and **11** \Rightarrow Fig. 104 to adjust the desired temperature inside the vehicle. We recommend you adjust the temperature to 22°C (72°F).

A comfortable interior climate is quickly reached when a temperature of 22°C (72°F) is set in automatic mode. Therefore, we recommend you not to change this adjustment, except as necessary to suit individual preferences or particular circumstances. The inside temperature can be set between +18°C (64°F) and +29°C (86°F). If a lower or higher temperature is selected, **LO** or **HI** are respectively displayed on the screen. These are approximate temperatures which may slightly vary depending on the outside conditions.

Climatronic maintains a constant temperature. To do so, it automatically regulates the supplied air temperature, the blower speed and the air distribution. The system also considers the sunlight radiation, so there is no need for manual readjustment. Therefore, **automatic mode** almost always provides the best comfort for the vehicle occupants throughout the year.

Automatic mode is switched off whenever an adjustment is made using the buttons for air distribution or blower. The temperature continues to self-regulate. ■

Manual mode

In manual mode the air temperature, flow, and the desired air distribution can be adjusted.

Switching on manual mode

- Press one of the buttons \Rightarrow Fig. 104 **14** to **16** or press the blower control **8** and **9** down. The indicator is switched off **3**.

Temperature

The inside temperature can be set between +18°C (64°F) and +29°C (86°F). These are approximate temperatures which may slightly vary depending on the outside conditions.

If a temperature below 18°C (64°F), is selected, the display switches to **LO** in this setting the system runs at maximum cooling output and the temperature is not regulated.

If a temperature above 29°C (86°F) is selected, the display switches to **HI** in this setting the system runs at maximum heating output and the temperature is not controlled.

Blower

The blower can be adjusted with buttons **8** and **9** \Rightarrow Fig. 104. If the blower is off (level **1** is not shown on the screen) and button **9** is pressed after 1 second, the Climatronic switches off.

Air distribution



The air distribution is adjusted using the buttons **20**, **22** and **24**. It is also possible to open and close some of the air outlets separately.

Switching the air conditioning on and off

Pressing the button **AC** the air cooling system can be switched off in order to save fuel. The temperature continues to self-regulate. The set temperature can then only be reached if it is higher than the outside temperature. ■

Air recirculation mode

Air recirculation mode prevents fumes or unpleasant smells from coming from the outside.

- Press the button  to switch air recirculation mode on or off. This is ON if the symbol  ⇒ Fig. 104 is displayed on the screen.

Air recirculation mode prevents strong odours in the ambient air from entering the vehicle interior, for example when passing through a tunnel or in a traffic jam.

When the outside temperature is low, air recirculation mode improves heating performance by heating air from the interior instead of cold air from the outside.

When the outside temperature is high, air recirculation mode improves cooling performance by cooling air from the interior instead of warm air from outside.

For safety reasons, the air recirculation **should not be switched on** when the air distribution control is set to the windscreen setting .



WARNING

In air recirculation mode, no cold air from the outside enters the vehicle interior. If the air conditioner is switched off, the windows can quickly mist over. Therefore, never leave the air recirculation mode switched on for a long time (risk of accident).



Note

When engaging reverse gear, the air recirculation is connected automatically to prevent the entrance of exhaust gases in the vehicle on travelling backwards. In this case the symbol  for air recirculation is not displayed. ■

General notes

Pollution filter

The pollution filter (a combined particulate filter and active carbon filter) serves as a barrier against impurities in the outside air, including dust and pollen.

For the air conditioner to work with maximum efficiency, the pollution filter must be replaced at the specified intervals in the Maintenance Programme.

If the filter loses efficiency prematurely due to use in areas reaching very high pollution levels, the pollen filter must be changed more frequently than stated in the Service Schedule.



CAUTION

- If you suspect that the air conditioner is damaged, switch it off with button  to prevent further damage and have it checked by a specialised workshop.
- Repairs to the air conditioner require specialist knowledge and special tools. Therefore, we recommend you to take the vehicle to a specialised workshop.



Note

- If the humidity and temperature outside the vehicle are high, **condensation** can drip off the evaporator in the cooling system and so forming a puddle underneath the vehicle. This is completely normal and there is no need to suspect a leak.
- Keep the air intake slots in front of the windscreen free of snow, ice and leaves to ensure heating and cooling are not impaired, and to prevent the windows from misting over.
- The air from the vents flows through the vehicle interior and is extracted by slots designed for this purpose. Therefore, do not cover these slots with items of clothing or other objects. ▶

- The air conditioner operates most effectively with the windows and the sliding/tilting sunroof* closed. However, if the temperature inside the vehicle is excessive because of the sun, the air inside can be cooled faster by opening the windows for a short time.
- Do not smoke while air recirculation mode is on, as smoke drawn into the air conditioning system leaves a residue on the evaporator, producing a permanent unpleasant odour.
- At low outside temperatures the compressor switches off automatically. The **(AUTO)** button cannot be switched on either.
- It is advisable to connect the air conditioning at least once a month, to lubricate the system gaskets and prevent leaks. If a decrease in the cooling capacity is detected, a Technical Service should be consulted to check the system.
- To ensure correct operation, the grilles on both sides of the screen must not be obstructed
- When the engine is under extreme strain, switch off the compressor for a moment. ■

Driving

Steering

Adjusting the steering wheel position

The height and reach of the steering wheel can be freely adjusted to suit the driver.

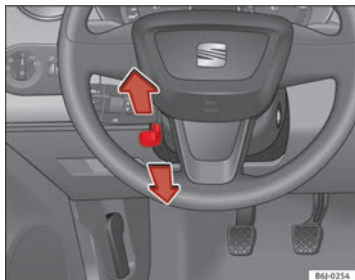

Fig. 105 Steering column height adjustment

- Adjust the driver seat to the correct position.
- Push the lever under the steering column ⇒ Fig. 105 down ⇒ ⚠.
- Adjust the steering wheel until the correct position is set ⇒ Fig. 105.
- Then push the lever up again firmly ⇒ ⚠.

⚠ WARNING

- Incorrect use of the steering column adjustment function and an incorrect seating position can result in serious injury.
- To avoid accidents, the steering column should be adjusted only when the vehicle is stationary.
- Adjust the driver seat or steering wheel so that there is a distance of at least 25 cm between the steering wheel and your chest ⇒ Fig. 105. If you fail to observe the minimum distance, the airbag will not protect you. Risk of fatal injury.
- If your physical constitution does not allow you to maintain the minimum distance of 25 cm, contact a Technical Service. Here you will be helped to decide if special specific modifications are necessary.
- If you adjust the steering wheel so that it points towards your face, the driver airbag will not protect you properly in the event of an accident. Make sure that the steering wheel points towards your chest.
- When driving, always hold the steering wheel with both hands on the outside of the ring at the 9 o'clock and 3 o'clock positions. Never hold the steering wheel at the 12 o'clock position, or in any other manner (e.g. in the centre of the steering wheel, or on the inside of the rim). In such cases, if the airbag is triggered, you may sustain injuries to the arms, hands and head.

Safety

Electronic Stability Control (ESC)*

The ESC helps make driving safer in extreme driving conditions.



Fig. 106 Detailed view of the dash panel: ESC switch.

The Electronic Stability Control (ESC) contains the electronic differential lock (EDL) and the traction control system (ASR). The ESC works together with the ABS. Both control lamps will light up if the ESC or ABS systems are faulty.

The ESC system is started automatically when the engine is started.

The ESC system is always active and cannot be switched off. The ESC switch only switches the ASR off.

! WARNING

- Do not forget that the Electronic stability control ESC cannot defy the laws of physics. This should be kept in mind, particularly on slippery and wet roads and when towing a trailer.
- Always adapt your driving style to suit the condition of the roads and the traffic situation. The greater safety provided by the ESC should not encourage you to run any risks.
- Please refer to the corresponding warning notes on ESC in ⇒ page 168, Intelligent technology.

Ignition lock

Position of the ignition key

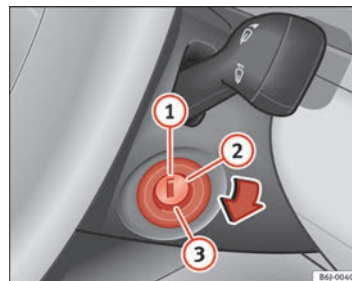

Fig. 107 Ignition key positions

Ignition switched off, steering lock ①

In this position → Fig. 107 the ignition and the engine are OFF and the steering may get locked.

For the **Steering lock** to operate without the ignition key, turn the steering wheel until it locks with an audible sound. You should always lock the steering wheel when you leave your vehicle. This will help prevent vehicle theft → ⚠.

Switching the ignition or the glow plug system on ②

Turn the ignition key to this position and release it. If the key cannot be turned or it is difficult to turn from position ① to position ②, move the steering wheel from one side to the other until it is released.

Starting ③

The engine is started when the key is in this position. Electrical components with a high power consumption are switched off temporarily.

Every time the vehicle is started again, the ignition key must be turned to position ①. The **repetitive start prevention lock** of the ignition prevents possible damage to the starter motor if the engine is already running.

⚠ WARNING

- The ignition key must NOT be removed from the lock until the vehicle comes to a standstill. Otherwise, the steering could be immediately blocked- Risk of accident!
- Always remove the key from the ignition when leaving the vehicle, even for a short period. This is especially important if children or disabled people are left alone in the vehicle. They could accidentally start the engine or work electrical equipment such as the electric windows, consequently resulting in an accident.
- Unsupervised use of the keys could start the engine or any electrical system, such as the electric window. This could result in serious injury.

⚠ CAUTION

The starter motor will only work when the engine is stopped (ignition key position ③).

Electronic immobiliser

The electronic immobiliser prevents unauthorised persons from driving the vehicle.

Inside the key there is a chip that deactivates the electronic immobiliser automatically when the key is inserted into the ignition.

The electronic immobiliser will be activated again automatically as soon as you pull the key out of the ignition lock.

The engine can only be started using a genuine SEAT key with its correct code.

i Note

A perfect operation of the vehicle is ensured if genuine SEAT keys are used.

Starting and stopping the engine

Starting petrol engines

The engine can only be started using a genuine SEAT key with its correct code.

- Move the gearbox lever to the neutral position and depress the clutch pedal thoroughly and hold it in this position for the starter to turn the engine on.
- Turn the ignition key to the starting ⇒ page 145 position.
- Let go of the ignition key as soon as the engine starts; the starter motor must not run on with the engine.

After starting a very hot engine, you may need to slightly press down the accelerator.

When starting a very cold engine, it may be a little noisy for the first few seconds until oil pressure has built up in the hydraulic valve compensators. This is quite normal, and no cause for concern.

If the engine does not start immediately, switch the starter off after 10 seconds and try again after half a minute. If the engine still does not start, the fuel pump fuse should be checked ⇒ page 231, Fuses.



WARNING

- Never start or run the engine in unventilated or closed rooms. The exhaust gases contain carbon monoxide, an odourless and colourless poisonous gas. Risk of fatal accidents. Carbon monoxide can cause loss of consciousness. It can also result in death.
- Never leave the vehicle unattended if the engine is running.
- Never use “cold start sprays”, they could explode or cause the engine to run at high revs. Risk of injury.



CAUTION

- When the engine is cold, you should avoid high engine speeds, driving at full throttle and over-loading the engine. Risk of engine damage.
- The vehicle should not be pushed or towed more than 50 metres to start the engine. Unburnt fuel could enter the catalytic converter and damage it.
- Before attempting to push-start or tow a vehicle in order to start it, you should first try to start it using the battery of another vehicle. Note and follow the instructions in ⇒ page 248, Jump-starting.



For the sake of the environment

Do not warm-up the engine by running the engine with the vehicle stationary. Start off immediately, driving gently. This helps the engine reach operating temperature faster and reduces emissions. ■

Starting diesel engines

The engine can only be started using a genuine SEAT key with its correct code.

- Move the gearbox lever to the neutral position and depress the clutch pedal thoroughly and hold it in this position for the starter to turn the engine on.
- Turn the ignition key to the starting position.
- Turn the ignition key to position ⇒ Fig. 107 ②. The warning lamp  will light for engine pre-heating.
- When the lamp turns off, turn the ignition key to position ③ to start the engine. Do not press the accelerator.
- Let go of the ignition key as soon as the engine starts, the starter motor must not be allowed to run on with the engine.

When starting a very cold engine, it may be a little noisy for the first few seconds until oil pressure has built up in the hydraulic valve compensators. This is quite normal, and no cause for concern.

If there are problems starting the engine, see the ⇒ page 248.

Glow plug system for the diesel engine

To avoid unnecessary discharging of the battery, do not use any other major electrical equipment while the glow plugs are pre-heating.

Start the engine as soon as the glow plug warning lamp goes out.

Starting the diesel engine after the fuel tank has been completely run dry

If the fuel tank has been completely run dry, it may take longer than normal (up to one minute) to start a diesel engine after refuelling. This is because the fuel system must eliminate air first.



WARNING

- Never start or run the engine in unventilated or closed rooms. The exhaust gases contain carbon monoxide, an odourless and colourless poisonous gas. Risk of fatal accidents. Carbon monoxide can cause loss of consciousness. It can also result in death.
- Never leave the vehicle unattended if the engine is running.
- Never use “cold start sprays”, they could explode or cause the engine to run at high revs. Risk of injury.



CAUTION

- When the engine is cold, you should avoid high engine speeds, driving at full throttle and over-loading the engine. Risk of engine damage.
- The vehicle should not be pushed or towed more than 50 metres to start the engine. Unburnt fuel could enter the catalytic converter and damage it.
- Before attempting to push-start or tow a vehicle in order to start it, you should first try to start it using the battery of another vehicle. Note and follow the instructions in ⇒ page 248, Jump-starting.



For the sake of the environment

Do not warm-up the engine by running the engine with the vehicle stationary. You should drive off as soon as you start the engine. This helps the engine reach operating temperature faster and reduces emissions. ■

Switching off the engine

- Stop the vehicle.
- Turn the ignition key to position ⇒ Fig. 107 ①.

After switching the engine off, the radiator fan may run on for up to 10 minutes. It is also possible that the fan turns itself on once more if the coolant ►

temperature increases due to the heat accumulated in the engine compartment or due to its prolonged exposure to solar radiation.

WARNING

- **Never switch the engine off until the vehicle is completely stationary.**
- **The brake servo works only when the engine is running. With the engine switched off, more strength is needed to brake. As normal brake operation cannot be performed, risk of accidents and serious injury may exist.**
- **The steering lock can be immediately blocked once the key is removed from the ignition. The vehicle cannot be steered. Risk of accident.**

CAUTION

When the engine has been running under a heavy load for a long period, heat can accumulate in the engine compartment and cause engine damage. For this reason, you should idle the engine for approx. 2 minutes before you switch it off.

Driving with LPG*



Fig. 108 Centre console: gas system control switch.

Your SEAT vehicle has a bivalent engine able to run on either LPG or petrol. The LPG tank ⇒ page 196, Refuelling with LPG is in the spare wheel well ⇒ .

It is possible to change from LPG to petrol while the engine is running, even if the vehicle is moving, by pressing the  **LPG** button located on the centre console ⇒ Fig. 108.

Starting the engine

The engine is always started with petrol, even when LPG was being used when it was switched off.

Automatic switch from petrol to LPG

When the engine is turned on and the following conditions are met, the system will automatically switch from petrol mode to LPG mode, the notification **changed to GAS mode** is displayed and the green warning lamp on the instrument panel lights up: ▶

- There is enough LPG in the tank.
- The temperature of the vehicle coolant is above 30°C.
- Engine speed while driving is above 1200 rpm.

Automatic switch from LPG to petrol

When the vehicle is operating in LPG mode and one of these conditions is met, the system automatically switches to petrol mode, the notification **changed to petrol mode** is displayed and the green warning lamp on the instrument panel goes out:

- When the engine is started.
- If the LPG tank is empty.
- If there is a fault in the LPG system.
- At very low temperatures below minus 10°C.

Manual switch from petrol to LPG

Press the  **LPG** button on the centre console ⇒ Fig. 108 to change mode. The notification **changed to GAS mode** is displayed. When the following conditions are met, the system switches to LPG mode, the green warning lamp on the instrument panel lights up and the notification displayed changes to **changed to GAS mode**.

- There is enough LPG in the tank.
- The temperature of the vehicle coolant is above 30°C.
- Engine speed while driving is above 1200 rpm.

Manual switch from LPG to petrol

Press the  **LPG** button on the centre console ⇒ Fig. 108 to change mode. The green lamp on the instrument panel goes out and the notification **changed to petrol mode** is displayed.

Running on petrol

Run the engine with petrol for short journeys at regular intervals to avoid problems in the petrol system.



WARNING

LPG is a highly explosive and inflammable substance. It may cause severe burns and other injury.

- Due care must be taken to avoid any risk of fire or explosion.
- **When parking the vehicle in a closed area (for example in a garage), make sure that there is adequate ventilation, either natural or mechanical, to neutralise the LPG in the event of a leak.**



Note

- If frequent short journeys are made, especially when the outside temperature is low, the vehicle will tend to run on petrol more often than on LPG. Therefore, the petrol tank may empty before the LPG tank.
- The notification **LPG mode not possible** may be displayed. ■

Start-Stop function*

Description and operation

The Start-Stop function stops the engine when the vehicle is stopped and starts it automatically when required.

- When the vehicle is stopped, put it in neutral and release the clutch pedal. The engine will stop.
- When the clutch pedal is pressed, the engine starts again.
- The instrument panel display shows information about the status of the Start-Stop function ⇒ Fig. 110. ▶

Start-Stop function conditions

- The driver seat belt must be buckled.
- The bonnet must be closed.
- The engine must be at operating temperature.
- The steering wheel must be straight.
- The vehicle must be on flat ground.
- The vehicle must not be in reverse.
- A trailer must not be connected.
- The temperature of the interior must be within the convenience limits (AC) button should be selected).
- The windscreen de-mist function must be off.
- If in an increase in airflow is **not** requested.
- The temperature must not be set to **HI** or **LO**.
- The driver door must be closed.
- The diesel particulate filter must not be in regeneration mode, for diesel engines.
- The battery charge must not be low for the next start.
- The battery temperature must be between -1°C and 55°C .

Start-Stop function interruption

In the following situations, the Start-Stop function will be interrupted and the engine will automatically start:

- The vehicle starts moving.
- The brake pedal is pressed several times in a row.
- The battery has been discharged excessively.
- The Start-Stop System is manually deactivated.
- The windscreen de-mist function is turned on.
- The temperature of the interior exceeds the convenience limits (AC) button).
- If the airflow is increased by more than 3 presses.

- Temperature setting **HI** or **LO** is selected.
- The engine coolant temperature is insufficient.
- The alternator is faulty, for example the V-belt has ruptured.
- If any of the conditions described in the previous section are not fulfilled.



WARNING

Never allow the vehicle to move with the engine off for any reason. You could lose control of your vehicle. This could cause an accident and serious injury.

- **The brake servo does not work with the engine off. You need more force to stop the vehicle.**
- **Power steering does not work when the engine is not running. That is why it is much more difficult to turn the steering wheel.**
- **Turn off the Start-Stop system when driving through water (fording streams, etc.).**



Note

- For vehicles with the Start-Stop function and a manual gearbox, when the engine is started, the clutch must be pressed.
- When the conditions for the Start-Stop function are not fulfilled, the instrument panel displays the Start-Stop indicator dimmed.
- If the steering wheel is turned more than 270° , it will not be possible to start the vehicle again. To start the vehicle, straighten the steering wheel so that it is turned less than 270° .

Activating and deactivating the Start-Stop function



Fig. 109 The Start-Stop function button.

Every time the ignition is switched on, the Start-Stop function is automatically switched on.

Manually deactivating the Start-Stop function

- Press the  => Fig. 109 button located on the centre console. When the Start-Stop function is switched off, the warning lamp comes on.
- If the Start-Stop function is operating then the engine starts immediately.

Switching the Start-Stop function on manually

- Press the  => Fig. 109 button located on the centre console. The warning lamp will switch off.

Driver messages

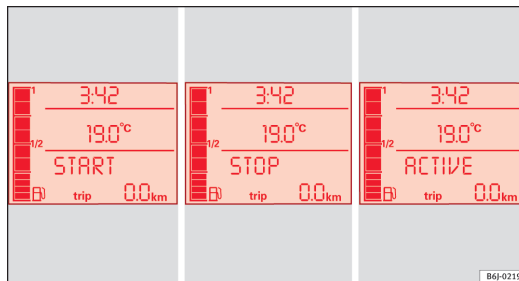

Fig. 110 Display on the instrument panel during Start-Stop function operation.

When the engine is turned off by the Start-Stop function, this is displayed on the instrument panel.

If the Start-Stop system is not switched on, the  lamp will appear on the instrument panel.



Note

There are different versions of the dash panel; the display of indications on the screen may differ. ■

Manual gearbox

Driving with a manual gearbox

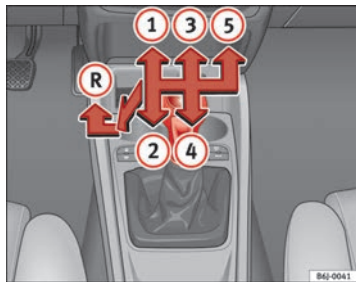

Fig. 111 Centre Console: gear shift pattern of a 5-speed manual gearbox

Engaging the reverse gear

- The vehicle should be stationary with the engine idling. Press the clutch down thoroughly.
- Place the gearbox lever into neutral and push the lever downwards.
- Slide the gearbox lever to the left, and then into the reverse position shown on the lever.

Certain versions of the model may include a 6-speed manual gearbox, and its diagram is shown on the gearbox lever.

The reverse gear can only be engaged when the vehicle is stationary. When the engine is running and before engaging this gear, wait about 6 seconds with the clutch pressed down thoroughly in order to protect the gearbox.

The reverse lights switch on when the reverse gear is selected and the ignition is on.

WARNING

- When the engine is running, the vehicle will start to move as soon as a gear is engaged and the clutch released.
- Never select the reverse gear when the vehicle is in motion. Risk of accident.

Note

- Do not rest your hand on the gear lever while driving. The pressure of your hand could cause premature wear on the selector forks in the gearbox.
- When changing gear, you should always depress the clutch fully to avoid unnecessary wear and damage.
- Do not hold the vehicle “on the clutch” on hills. This causes premature wear and damage to the clutch.
- Do not leave your foot on the clutch pedal; although the pressure may seem insignificant, it can cause the premature wear of the clutch plate. Use the foot rest when you do not need to change gear.

Automatic gearbox*

Gearbox programmes

The automatic gearbox has got two gearbox programmes.



Fig. 112 Automatic gearbox

Selecting the normal programme

- Put the selector lever into position D.

Selecting the sport programme

- Put the selector lever into position S.

If you select the normal programme, **D**, you will drive in the economy mode, i.e. the programme is designed to reduce fuel consumption. The gearbox changes up into a higher gear as soon as possible and down into a lower gear as late as possible.

If you select the sport programme, **S**, you will drive in a sporty mode, i.e. a programme in which shifts into high gears are postponed in order to use the full power of the engine. ■

Selector lever lock

The selector lever lock in position P or N prevents gears from being engaged inadvertently, which would cause the vehicle to move.

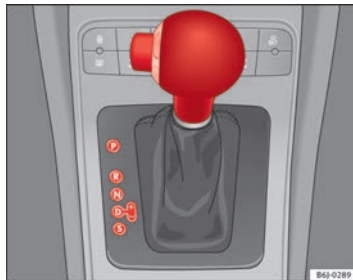



Fig. 113 Automatic gearbox



Fig. 114 Automatic gearbox: Instrument panel display ▶

The selector lever lock is released as follows:

- Switch the ignition on.
- Hold the brake pedal pressed down and at the same time, hold the selector lever lock on the left of the selector lever also pressed down.

The warning lamp  on the instrument panel lights up when the brake pedal should be applied. This is essential when the selector lever is taken from the P or N positions.

The selector lever lock only works if the vehicle is stationary or driving at speeds up to 5 km/h (3 mph). At higher speeds the selector lever lock is automatically unlocked in the **N** position.

The selector lever lock is not engaged if the selector lever is moved quickly through position **N** (e.g. when shifting from **R** to **D**). This makes it possible, for instance, to “rock” the vehicle backwards and forwards if it is stuck in snow or mud. The selector lever lock engages automatically if the brake pedal is not depressed and the lever is in position **N** for more than about 1 second.

Driving a car with an automatic gearbox

The gearbox changes gear ratios automatically as the vehicle moves.

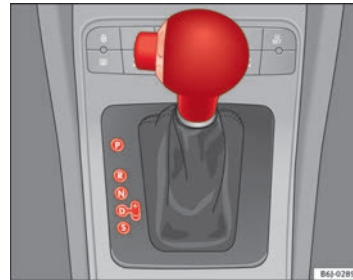



Fig. 115 Automatic gearbox

Starting

- Start the engine with the selector lever in position **P** or **N**.

Driving

- Hold the brake pedal pressed down.
- By holding the lock button (button on the left in the selector lever), select **R**, or **D**.
- Release the lever and wait a little for the gearbox to engage the gear (a slight movement can be felt).
- Release the brake and press the accelerator =>  

Stopping briefly

- If stopping for a short time, keep the vehicle stationary by pressing the foot brake hard to prevent the vehicle moving backwards on a slope or “creeping” forwards, e.g. at traffic lights. The selector lever does not need to be put into the positions **P** or **N**.
- Do not press the accelerator.

Parking

- Press and hold the brake pedal until the vehicle comes to a standstill ⇒ .
- Apply the handbrake.
- By pressing the lock button down, move the selector lever to **P** and release the lock button.

Driving up and down hills

- Press the selector lever from position “D” to the right into the tiptronic selector gate.
- Lightly press the selector lever back to change down.

Holding the car on a hill

- The brake must be always pressed down to prevent the vehicle from “rolling backwards” ⇒ . Do not try to prevent the vehicle from rolling backwards by increasing the engine speed while a range of gears is selected.

Starting the vehicle up hills

- Apply the handbrake.

- With a selected gear, accelerate slowly and at the same time, release the handbrake.

The steeper the slope, the lower the needed gear. This increases the braking effect of the engine. For example, when driving down a very steep slope in third gear. If the engine brake effect is not enough, the vehicle will speed up. The automatic gearbox automatically changes up to prevent the engine over-revving. Use the foot brake to reduce speed and change into third gear again using Tiptronic* ⇒ .

Your vehicle has an automatic interlock which prevents the selector lever from being put into a position for driving forwards or in reverse from positions **P** or **N** if the brake pedal is not depressed.

The ignition key cannot be removed unless the selector lever is in position **P**.

Control lamp “Pressing brake pedal”

When the warning lamp next to the selector lever lights up, press the brake pedal. This is necessary when the automatic gearbox selector lever is moved out of positions **P** or **N**. At the same time, a text message or the instructions to perform necessary operations may appear on the instrument panel.



WARNING

- As a driver, you should never leave your vehicle if the engine is running and a gear is engaged. If you have to leave your vehicle while the engine is running, you must apply the parking brake and put the selector lever in position **P**.
- If the engine is running and **D** or **R** are engaged, you will need to hold vehicle stopped by depressing the brake pedal. The vehicle would keep on creeping forward as the power transmission is not fully interrupted even when the engine is idling. 

⚠ WARNING (Continued)

- Never accelerate when moving the selector lever or you may cause an accident.
- Never move the selector lever to R or P when driving. Risk of accident!
- Before driving down a long, steep slope, it is advisable to reduce speed and change into a lower gear.
- If you stop the vehicle up hill, always hold the foot brake strongly depressed down to stop it from rolling back.
- Never allow the brake to rub and do not use the brake pedal too often or for long periods. Constant braking will cause the brakes to overheat and will considerably reduce the brake effect. This increases the braking distance and could cause the brake system to fail.
- Never allow the vehicle to roll down a mountain or a slope with the lever in the N or D position, regardless of whether the engine is running or not.

⚠ CAUTION

- If you stop the vehicle up hills, do not attempt to stop it from rolling back by depressing the accelerator when a gear has been selected. Otherwise, the automatic gearbox may overheat causing damage. Pull the hand-brake up or fully depress the brake pedal to prevent the vehicle from rolling away.
- If you allow the vehicle to roll when the engine is not running, or with the selector lever in position N, a lack of lubrication in the automatic gearbox will damage it.

Changing gear in tiptronic mode*

The tiptronic system allows the driver to select gears manually

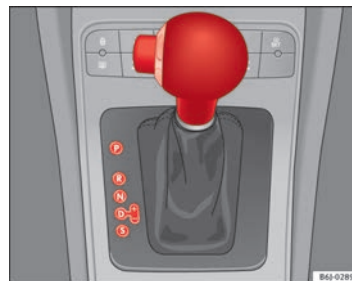

Fig. 116 Changing gear with tiptronic





Fig. 117 Steering wheel with paddle levers for automatic gearbox

General information about driving in tiptronic mode ▶

Changing gear in tiptronic mode

- Press the selector lever from position **D** to the right into the tiptronic selector gate.
- Lightly press the selector lever forward + to change up into high gears.
- Lightly press the selector lever backwards - to change down into low gears.

Changing gear with the steering wheel paddle levers*

- Press the right paddle lever  towards the steering wheel to change up. ⇒ Fig. 117.
- Press the left paddle lever  towards the steering wheel to change down. ⇒ Fig. 117.

Using the paddle levers on the steering wheel, you can access manual driving mode regardless of the pre-selected driving mode.

General information about driving in tiptronic mode

When accelerating, the automatic gearbox / DSG automatic gearbox goes into a higher gear a little before the engine reaches its maximum permitted revolutions.

If a lower gear is selected, the automatic gearbox / DSG automatic gearbox will only change down when the engine cannot go over its maximum permitted revolutions.

If tiptronic is selected whilst the vehicle is in motion and the automatic gearbox / DSG automatic gearbox is in third gear and selector lever position **D**, tiptronic mode will then also be in third gear.

Changing gears in the normal or sport programme using the steering wheel paddle levers

If the paddle levers ⇒ Fig. 117 are used in the normal or sport programme, the system switches temporarily to tiptronic mode. To exit "tiptronic" mode again, press the right paddle lever  towards the steering wheel for approximately one second. You will also leave tiptronic mode if the paddle levers are not moved for a certain time.



Note

- The gear paddle levers on the steering wheel can be operated with the selector lever in any position and with the vehicle in motion. ■

Selector lever positions

The selector lever positions and gears are shown on the instrument panel display.



Fig. 118 Automatic gearbox: Instrument panel display ▶

Selector lever positions

The selected gear is displayed on the side of the selector lever and on the instrument panel display. The currently selected gear for the automatic gearbox will also be shown on the display.

Tiptronic gear indicator

If the automatic gearbox is shifted manually, the selected gears are shown on the screen.

P - parking lock

When the selector lever is in this position, the driven wheels are locked mechanically.

Position P on the lever must only be selected if the vehicle is stationary.

To move selector lever from position **P**, the locking button on the selector lever handle must be pressed and the brake pedal depressed at the same time while the ignition is switched on.

To put the selector lever in position **P**, simply press the lock button down and, if necessary, depress the brake pedal down.

R - Reverse gear

The reverse gear is engaged in this position.

Reverse gear must be engaged only when the vehicle is stationary and the engine is idling.

To move the selector lever to position **R**, press the lock button down and, at the same time, press the brake pedal down, with the ignition switched on.

With the selector lever in position **R** and the ignition switched on the following occurs:

- Reverse lights light up.
- The air conditioner automatically changes the air recirculation mode.

- The wiper starts if the windscreen washer is on.
- The parking distance warning system switches on.*

N - Neutral (idling)

If this position is selected, the gearbox is in neutral. Power is not transmitted to the wheels and the engine does not have a braking function.

Never use the **N** position to drive down a hill. The engine does not function as a brake and the brakes are subjected to excessive stain.

You could damage the automatic gearbox if you drive down hills with the gearbox lever in position **N** and the engine switched off.

D - Drive (forward)

In this position the gearbox automatically changes to a lower or higher gear, according to the engine's requirements, the driving style and speed. The braking effect of the engine when driving downhill is very limited when the selector is in this position. The instrument panel display shows the selected gear as well as the selector lever in position **D**.

If position **N** has been selected and you wish to select **D**, you must press the foot brake if the vehicle is stationary, or travelling at under 5 km/h (3 mph).

S - Standard driving position (Sport programme)

When the selector lever is in position **S**, it will automatically change up into a higher gear later, and change down into a low gear, if compared with position **D**. This way, it is possible to take full advantage of the engine reserve power, depending on the engine demand, driving style and speed. The braking effect of the engine when driving downhill is very limited. On the instrument panel display the selected gear is shown as well as the selector lever to position **S**.

To select gear range **S**, press the lock button on the selector lever. ▶

 **WARNING**

If the vehicle moves with no control, an accident and serious injury may occur.

- As a driver, you should never leave your vehicle if the engine is running and a gear is engaged. If you have to leave your vehicle while the engine is running, you must always apply the handbrake and engage the parking lock position P.
- If the engine is running and if D or R are engaged, you will need to hold the vehicle stopped by depressing footbrake down. The vehicle would creep forward as the power transmission is not fully interrupted even when the engine is idling.
- Never accelerate when moving the selector lever or you may cause an accident.
- Never move the selector lever to "R" or "P" when driving. Risk of accident.
- Before driving down a very steep slope, reduce your speed and shift to first gear.
- Always hold the vehicle on the foot brake if you stop on hills. Otherwise, the vehicle could roll back.
- Never allow the brake to rub and do not use the brake pedal too often or for long periods. Constant braking will cause the brakes to overheat and will considerably reduce the brake effect. This increases the braking distance and could cause the brake system to fail.

 **WARNING**

Never switch the engine off until the vehicle is stationary. You could lose control of your vehicle. This could cause an accident and serious injury.

- The airbags and belt tensioners do not work when the ignition is switched off.

 **WARNING (Continued)**

- The brake servo does not work with the engine off. You need more force to stop the vehicle.
- Power steering does not work when the engine is not running. That is why it is much more difficult to turn the steering wheel.
- Never remove the key from the ignition if the vehicle is in motion. The steering lock could suddenly engage, and you would not be able to steer the vehicle.
- Never allow the vehicle to roll downhill with the selector lever in "N", regardless of whether the engine is running or not.

 **CAUTION**

If you allow the vehicle to move when the engine is switched off or with the selector lever in position "N", take your foot off the accelerator and wait until the engine starts idling before returning to position "D".

Kickdown feature

This feature allows maximum acceleration.

If you press the accelerator down thoroughly, the gearbox automatically changes down, depending on speed and engine speed, into a lower gear to take full advantage of give the vehicle maximum acceleration.

The gearbox does not change gear until the engine reaches the maximum determined engine speed for the gear.

WARNING

You could lose control of the vehicle if you accelerate on slippery road surfaces. Risk of serious injury.

- Be particularly careful when using the kickdown features on slippery road surfaces. With a fast acceleration, the vehicle could lose traction and skid.
- You should use the kickdown feature only when traffic and weather conditions allow it to be used safely.

Handbrake

Using the handbrake

The handbrake should be applied firmly to prevent the vehicle from accidentally rolling away.

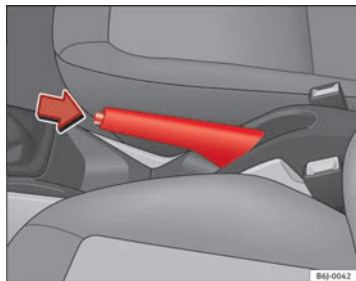



Fig. 119 Handbrake between the front seats

Always apply the handbrake when you leave your vehicle and when you park.

Applying the handbrake

- Pull the handbrake lever up firmly ⇒ Fig. 119.

Releasing the handbrake

- Pull the lever up slightly and press the release knob in the direction of the arrow ⇒ Fig. 119 and guide the handbrake lever down fully ⇒ .

Always apply the handbrake *as far as it will go* in order to prevent yourself from driving with the handbrake applied by mistake ⇒ .

The handbrake warning lamp  lights up when the handbrake is applied and the ignition switched on. The warning lamp turns off when the handbrake is released.

WARNING

- Never use the handbrake to stop the vehicle when it is in motion. The braking distance is considerably longer, because braking is only applied to the rear wheels. Risk of accident!
- If the handbrake is only partially released, this will cause the rear brakes to overheat, which can impair the function of the brake system and could lead to an accident. This also causes premature wear on the rear brake pads.

CAUTION

Always apply the handbrake before you leave the vehicle. The first gear should also be selected.

Parking

The handbrake should always be firmly applied when the vehicle is parked.

Always note the following points when parking the vehicle:

- Use the brake pedal to stop the vehicle.
- Apply the handbrake.
- Select first gear.
- Switch the engine off and remove the key from the ignition. Turn the steering wheel slightly to engage the steering lock.
- Always take your keys with you when you leave the vehicle ⇒ ⚠.

Additional notes on parking the vehicle on gradients:

Turn the steering wheel so that the vehicle rolls against the kerb if it started to roll.

- If the vehicle is parked facing **downhill**, turn the front wheels so that they point *towards the kerb*.
- If the vehicle is parked facing **uphill**, turn the front wheels so that they point *away from the kerb*.
- Secure the vehicle as normal by applying the handbrake firmly and selecting first gear.



WARNING

- Take measures to reduce the risk of injury when you leave your vehicle unattended.
- Never park where the hot exhaust system could ignite inflammable materials, such as dry grass, low bushes, spilled fuel etc.
- Never allow vehicle occupants to remain in the vehicle when it is locked. They would be unable to open the vehicle from the inside, and could become trapped in the vehicle in an emergency. In the event of an emergency, locked doors will delay assistance to vehicle occupants.
- Never leave children alone in the vehicle. They could set the vehicle in motion, for example, by releasing the handbrake or the gearbox lever.
- Depending on weather conditions, it may become extremely hot or cold inside the vehicle. This can be fatal.

Hill-start assist*

This function is only included in vehicles with ESC.

This device helps when starting uphill.

These are the basic operation conditions: doors closed, brake pedal pressed down and vehicle in neutral. The system gets activated on engaging gear.

After removing your foot from the brake pedal, the braking force is maintained for a few seconds to prevent the vehicle from moving backward when putting into gear. This short space of time is enough to start the vehicle with ease.

This system also works when reversing uphill. ▶

**WARNING**

- If you do not start the vehicle immediately after taking your foot off the brake pedal, the vehicle may start to roll back under certain conditions. Depress the brake pedal or use the handbrake immediately.
- If the engine stalls, depress the brake pedal or use the handbrake immediately.
- When following a line of traffic uphill, if you want to prevent the vehicle from rolling back accidentally when starting off, hold the brake pedal down for a few seconds before starting off.

**Note**

The Official Service or a specialised workshop can tell you if your vehicle is equipped with this system. ■

Acoustic parking aid system*

Rear parking aid

The parking aid system will use an audible warning to indicate of the approach of any object towards the rear of the vehicle.

Description

The acoustic parking aid system will measure the distance between the rear of the vehicle and any possible obstacle using four ultrasonic sensors located on the rear bumper. The measuring range of the sensors starts **approximately and depending on the nature of the obstacle** at a distance of:

- side of the rear bumper: 0.6 m
- middle of the rear bumper: 1.6 m

Activation

The system is activated by engagement of the reverse gear. A brief audible warning confirms the activation and correct function of the system.

Reverse gear

The distance warning will begin as soon as an obstacle is detected by the system. The frequency of the bleeps emitted by the system will increase rapidly as the vehicle approaches the obstacle.

Within a short distance of about 30cm, a continuous signal sounds (stop signal). The driver should not reverse any further.

Models with a factory-fitted towing bracket: When the vehicle is less than 0.35 m away from the obstacle the warning tone will sound continuously. The driver should then not reverse any further.

The warning tone decreases by 30% after 3 seconds from the start of the system.

Provided that it is not in continuous mode, the tone on the parking aid system stops when it detects a wall parallel to the vehicle.

Trailer towing

For vehicles factory-fitted with a towing bar, the parking aid system will not be activated by the engagement of the reverse gear when pulling a trailer, as the trailer's electric connector will be plugged into the vehicle.

Possible faults

If a continuous beep sounds for some seconds when the reverse gear is engaged, this indicates that there is a fault in the parking aid system.

If the fault continues until the ignition is turned off, the audible warning of the fault will not be emitted every time the system is reactivated (by engaging the reverse gear). Thus, the system ready indication will not sound either. Have the fault repaired by a Technical Service as soon as possible.

If there is no ready signal or no acoustic warning signal, then the parking aid loudspeaker is faulty and may not warn of obstacles. ►

To ensure that the system works properly, the sensors must be kept clean and free of ice and snow.



WARNING

- **The sensors have blind spots in which obstacles may not be detected.**
- **Always look out for small children and animals because the system will not always detect them. Always pay attention when reversing to avoid accidents.**
- **The parking aid is not a replacement for driver awareness. The driver must take full responsibility for parking and other manoeuvres.**



CAUTION

- Please note that low obstacles detected by the system may no longer be registered by the sensors as the car moves closer, so the system will not give any further warning. Certain kinds of obstacles (such as wire fences, chains, thin posts or trailer draw bars, high kerbs or painted railings etc) may not always be detected by the system, so there is a risk of damaging the vehicle in such cases.
- In some cases, obstacles with uniform edges and bumps may not be detected immediately by the system due to their geometry. Take special care of this type of obstacle (corners, rectangular objects, etc.), as they can cause damage to the vehicle.
- Be especially careful when manoeuvring into a corner between two perpendicular walls. Carefully watch the approach of the wall to the side of the vehicle (using the mirrors).
- The parking aid system does not replace use of the mirrors for manoeuvres.
- External ultra-sonic sources (pneumatic drills, construction machinery, other vehicles with PDC) may interfere with the operation of the system.
- Periodic cleaning of the sensors, take care not to damage or scratch them. When cleaning with high pressure washers or steam cleaners, the sensors should be sprayed for only a very short period and from a distance of more than 10 cm.

Cruise speed* (Cruise control system)

Description

The cruise control system is able to maintain the set speed in the range of 30 km/h (20 mph) to 180 km/h (110 mph).

Once the speed setting has been saved, you may take your foot off the accelerator.



WARNING

It could be dangerous to use the cruise control system if it is not possible to drive at constant speed.

- **Do not use the cruise control system when driving in dense traffic, on roads with lots of bends or on roads with poor conditions (with ice, slippery surfaces, loose grit or gravel), as this could cause an accident.**
- **Always switch the cruise control system off after using it in order to avoid an involuntary use.**
- **It is dangerous to use a set speed which is too high for the current road, traffic or weather conditions. Risk of accident.**



Note

The cruise control cannot maintain a constant speed when descending downhill. The vehicle will accelerate due to its own weight. Use the foot brake to slow the vehicle.

Switching the cruise control system on and off

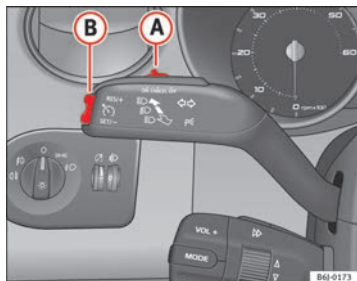



Fig. 120 Turn signal and main beam headlight lever; switch and rocker switch for the cruise control

Switching on the cruise control system

- Move the control ⇒ Fig. 120 (A) to the left to **ON**.

Switching off the cruise control system

- Move the control (A) to the right to **OFF** or turn the ignition off when the vehicle is stationary.

When the cruise control is on and a speed is programmed, the indicator  on the instrument panel is lit.¹⁾

If the cruise control system is *switched off*, the  symbol is switched off. The system will also be deactivated completely when **1st** gear is selected.* ■

¹⁾ Depending on the model version

Setting speed*

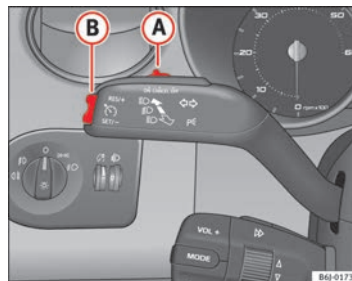

Fig. 121 Turn signal and main beam headlight lever; switch and rocker switch for the cruise control

- Press the lower part **SET** of the rocker switch ⇒ Fig. 121 (B) once briefly when you have reached the speed you wish to set.

When you release the rocker switch, the current speed is set and held constant. ■

Adjusting set speed*

The speed can be altered without touching the accelerator or the brake.

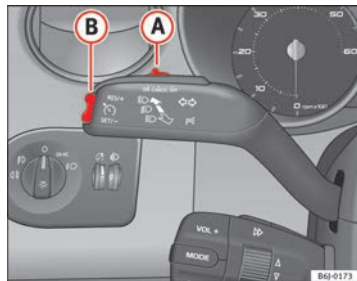

Fig. 122 Turn signal and main beam headlight lever: switch and rocker switch for the cruise control

Setting a higher speed

- Press the upper part **RES** of the rocker switch ⇒ Fig. 122 **(A)** to increase the speed. The vehicle will continue to accelerate as long as you keep the rocker switch pressed. When you release the switch, the new speed is stored.

Setting a lower speed

- Press the lower part **SET-** of the rocker switch **(B)** to reduce the speed. The vehicle will automatically reduce its speed for as long as you keep the switch pressed. When you release the switch, the new speed is stored.

When you increase speed with the accelerator and then release the pedal, the system will automatically restore the set speed. This will not be the case, however, if the vehicle speed is more than 10 km/h (mph) higher than

the stored speed for longer than 5 minutes. The speed will have to be stored again.

Cruise control is switched off if you reduce speed by depressing the brake pedal. Reactivate the control by pressing once on the upper part of the rocker switch **RES+** ⇒ Fig. 122 **(A)**.

! WARNING

It is dangerous to use a set speed which is too high for the current road, traffic or weather conditions. Risk of accident.

Switching off cruise control temporarily*

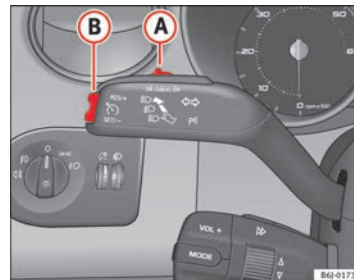

Fig. 123 Turn signal and main beam headlight lever: switch and rocker switch for the cruise control

The cruise control system will be switched off in the following situations:

- if the brake pedal is depressed,
- if the clutch pedal is depressed,

- if the vehicle is accelerated to over 180 km/h (110 mph),
- when the lever **(A)** is moved in the direction of **OFF** without fully being engaged.

To resume cruise control, release the brake or clutch pedal or reduce the vehicle speed to less than 180 km/h (110 mph) and press once on the upper part of the rocker switch **RES** → Fig. 123 **(B)**.

WARNING

It is dangerous to use a set speed which is too high for the current road, traffic or weather conditions. Risk of accident.

Completely switching off the system

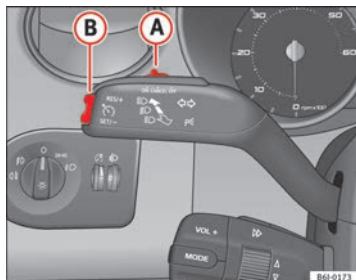

Fig. 124 Turn signal and main beam headlight lever: switch and rocker switch for the cruise control

Vehicles with a manual gearbox

The system is **completely turned off** by moving the control **(A)** all the way to the right hand side (OFF engaged), or when the vehicle is stationary, ignition off.

Vehicles with an automatic gearbox

To completely disengage the system, the selector lever must be placed in one of the following positions: **P**, **N**, **R** or **1** or with the vehicle stopped and the ignition turned off.

Practical Tips

Intelligent technology

Brakes

Brake servo

The brake servo increases the pressure you apply to the brake pedal. It works **only when the engine is running**.

If the brake servo is not functioning due to a malfunction, or if the vehicle has to be towed, you will have to press the brake pedal considerably harder to make up for the lack of servo assistance.

WARNING

The braking distance can also be affected by external factors.

- **Never let the vehicle coast with the engine switched off. Failure to do so could result in an accident. The braking distance is increased considerably when the brake servo is not active.**
- **If the brake servo is not working, for example when the vehicle is being towed, you will have to press the brake pedal considerably harder than normal.**

Hydraulic Brake Assist (HBA)*

The function (Hydraulic Brake Assist HBA) is only included in vehicles with ESC.

In an emergency, most drivers brake in time, but not with maximum force. This results in unnecessarily long braking distances.

This is when the brake assist system comes into action. When pressing the brake pedal rapidly, the assistant interprets it as an emergency. It then very quickly builds up the full brake pressure so that the ABS can be activated more quickly and efficiently, thus reducing the braking distance.

Do not reduce the pressure on the brake pedal. The brake assist system switches off automatically as soon as you release the brake.

Automatic hazard warning lights activation

The brake lights flash automatically to indicate that the vehicle is braking suddenly or in an emergency situation. If the emergency braking continues until the vehicle comes to a standstill, the hazard warning lights will then come on and the brake lights will remain on permanently from that moment. The warning lights will automatically switch off when the vehicle begins to move again or when the "warning" light button is pressed. ►

 **WARNING**

- The risk of accident is higher if you drive too fast, if you do not keep your distance to the vehicle in front, and when the road surface is slippery or wet. The increased accident risk cannot be reduced by the brake assist system.
- The brake assist system cannot defy the laws of physics. Slippery and wet roads are dangerous even with the brake assist system! Therefore, it is essential that you adjust your speed to suit the road and traffic conditions. Do not let the extra safety features tempt you into taking any risks when driving.

Anti-lock brake system and traction control ABS

Anti-lock brake system (ABS)

The anti-lock brake system prevents the wheels locking during braking.

The anti-lock brake system (ABS) is an important part of the vehicle's active safety system.

How the ABS works

If one of the wheels is turns too slowly in relation to the road speed, and is close to locking, the system will reduce the braking pressure for this wheel. The driver is made aware of this control process by a **pulsating of the brake pedal** and audible noise. This is a deliberate warning to the driver that one or more of the wheels is tending to lock and the ABS control function has intervened. In this situation it is important to keep the brake pedal fully depressed so the ABS can regulate the brake application. Do not "pump".

If you brake hard on a slippery road surface, the best possible control is retained as the wheels do not lock.

However, ABS will not necessarily guarantee shorter braking distances in *all* conditions. The braking distance could even be longer if you brake on gravel or on fresh snow covering a slippery surface.

 **WARNING**

- The anti-lock brake system cannot defy the laws of physics. Slippery and wet roads are dangerous even with ABS! If you notice that the ABS is working (to counteract locked wheels under braking), you should reduce speed immediately to suit the road and traffic conditions. Do not let the extra safety features tempt you into taking any risks when driving.
- The effectiveness of ABS is also determined by the tyres fitted → page 216.
- If the running gear or brake system is modified, the effectiveness of the ABS could be severely limited.

Drive wheel traction control system (ASR)*

The traction control system prevents the driven wheels from spinning when the vehicle is accelerating. The system always includes ABS

Description and operation of the traction control system during acceleration (ASR)

On front-wheel drive vehicles, the ASR system intervenes, reducing engine power and preventing the driven wheels from slipping during acceleration. The system works in the entire speed range in conjunction with ABS. If a failure occurs in the ABS, the ASR will also stop working.

The ASR helps the car to start moving, accelerate and climb a gradient in slippery conditions, where this may otherwise be difficult or even impossible.

The ASR automatically switches on when the engine is started. If necessary, it may be turned on or off by briefly pushing the ESC button on the centre console.

When the ASR is off, the warning lamp  is lit. The ASR should normally be left on. Only in exceptional circumstances, when the slipping of the wheels is required, can they be disconnected using the ESC button, for example.

- With compact temporary spare wheel.
- When using the snow chains.
- When driving in deep snow or on loose surfaces
- When the vehicle is bogged-down, to free it by rocking.

The ASR should be switched on again as soon as possible.



WARNING

- Remember that not even the ASR can defy the laws of physics. This should be kept in mind, particularly on slippery and wet roads and when towing a trailer.
- Always adapt your driving style to suit the condition of the roads and the traffic situation. The greater safety provided by the ASR should not encourage you to run any risks.



CAUTION

- To ensure that the ASR works correctly, identical tyres should be fitted on all four wheels. Any differences in the rolling radius of the tyres can cause the system to reduce engine power when this is not desired.
- Any modifications made to the vehicle (for example, to the engine, brake system, running gear or to the combination of wheels and tyres) may affect the operation of the ABS and ASR.

XDS*

Driveshaft differential

When taking a bend, the driveshaft differential mechanism allows the outer wheel to turn at a higher speed than the inner wheel. In this way, the wheel that is turning faster (outer wheel) receives less drive torque than the inner wheel. This may mean that in certain situations the torque delivered to the inner wheel is too high, causing the wheels to spin. On the other hand, the outer wheel is receiving a lower drive torque than it could transmit. This causes an overall loss of lateral grip on the front axle, resulting in under-steer or “lengthening” of the trajectory.

The XDS system can detect and correct this effect via the sensors and signals of the ESC.

Via the ESC, the XDS will brake the inside wheel and counter the excess driving torque of that wheel. This means that the driver's desired trajectory is much more precise,

The XDS system works in combination with the ESC and is always active, even when the ASR traction control is disconnected.

Electronic Stability Control (ESC)*

General notes

The Electronic Stability Control increases the vehicle's stability on the road.

The Electronic Stability Control helps reduce the danger of skidding.

The Electronic Stability Control (ESC) includes the systems **ABS, EDL and ASR**

Electronic Stability Control (ESC)*

The ESC reduces the risk of skidding by braking the wheels individually.

The system uses the steering wheel angle and road speed to calculate the changes of direction desired by the driver, and constantly compares them with the actual behaviour of the vehicle. When irregularities occur, for example, if the vehicle begins to skid, the ESC brakes the appropriate wheel automatically.

The forces acting on the braked wheel bring the vehicle back to a stable condition. If the vehicle tends to oversteer, the system will act on the front wheel on the outside of the turn.

⚠ WARNING

- **Remember that not even the ESC can defy the laws of physics. This should be kept in mind, particularly on slippery and wet roads and when towing a trailer.**
- **Always adapt your driving style to suit the condition of the roads and the traffic situation. The greater safety provided by the ESC should not encourage you to run any risks.**

**CAUTION**

- To ensure that the ESC works correctly, all four wheels must be fitted with the same tyres. Any differences in the rolling radius of the tyres can cause the system to reduce engine power when this is not desired.
- Any modifications made to the vehicle (for example, to the engine, brake system, running gear or to the combination of wheels and tyres) may affect the operation of the ABS, EDL, ESC and ASR.

Anti-lock brake system (ABS)

The anti-lock brake system prevents the wheels locking during braking
⇒ page 169.

Electronic differential lock (EDL)*

The electronic differential lock helps prevent the loss of traction caused if one of the driven wheels starts spinning.

EDL helps the vehicle to start moving, accelerate and climb a gradient in slippery conditions where this may otherwise be difficult or even impossible.

The system will control the revolutions of the driven wheels using the ABS sensors (in case of an EDL fault the warning lamp for ABS lights up)
⇒ page 71.

At speeds of up to approximately 80 km/h (50 mph), it is able to balance out differences in the speed of the driven wheels of approximately 100 rpm caused by a slippery road surface on *one side* of the vehicle. It does this by braking the wheel which has lost traction and distributing more driving force to the other driven wheel via the differential.

To prevent the disc brake of the braking wheel from overheating, the EDL cuts out automatically if subjected to excessive loads. The vehicle will continue to function normally without EDL. For this reason, the driver is not informed that the EDL has been switched off.

The EDL will switch on again automatically when the brake has cooled down.

**WARNING**

- When accelerating on a slippery surface, for example on ice and snow, press the accelerator carefully. Despite EDL, the driven wheels may start to spin. This could impair the vehicle's stability.
- Always adapt your driving style to suit road conditions and the traffic situation. Do not let the extra safety afforded by EDL tempt you into taking any risks when driving, this can cause accidents.

**CAUTION**

Modifications to the vehicle (e.g. to the engine, the brake system, running gear or any components affecting the wheels and tyres) could affect the efficiency of the EDL ⇒ page 190. ■

Drive wheel traction control system ASR

The traction control system prevents the driven wheels from spinning when the vehicle is accelerating ⇒ page 169. ■

Driving and the environment

Running-in

Running in a new engine

The engine needs to be run in over the first 1500 km (1000 miles).

Up to 1000 kilometres (600 miles)

- Do not drive at speeds of more than 2/3 the maximum speed.
- Do not accelerate hard.
- Avoid high engine revolutions.
- Do not tow a trailer.

From 1000 to 1500 kilometres (600 to 900 miles)

- Speeds can be *gradually* increased to the maximum road speed or maximum permissible engine speed (rpm).

During its first few hours of running, the internal friction in the engine is greater than later on, when all the moving parts have bedded in.



For the sake of the environment

If the engine is run in gently, its life will be increased and its oil consumption reduced.

Running in tyres and brake pads

New tyres should be run-in carefully for the first 500 km (300 miles). New brake pads should be run-in carefully for the first 200 km (120 miles).

During the first 200 km (120 miles), you can compensate for the reduced braking effect by applying more pressure to the brake pedal. In case of a sharp braking, the braking distance will be longer with new brake pads than with brake pads which have been run-in.



WARNING

- At first, new tyres do not give maximum grip, and require running-in. This may cause an accident. Drive particularly carefully in the first 500 km (300 miles).
- New brake pads must be “run in” and do not have the correct friction properties during the first 200 km (120 miles). However, the reduced braking capacity may be compensated by pressing on the brake pedal a little harder.

Braking capacity and braking distance

The braking capacity and braking distance are influenced by driving situations and road conditions.

The efficiency of the brakes depends directly on the **brake pad** wear. The rate of wear of the brake pads depends to a great extent on the conditions under which the vehicle is operated and the way the vehicle is driven. If you often drive in town, drive short distances or have a sporty driving style, we ►

recommend that you have the thickness of your brake pads checked by a Technical Service more frequently than recommended in the Maintenance Programme.

If you drive with **wet brakes**, for example, after crossing areas of water, in heavy rainfall or even after washing the vehicle, the effect of the brakes is lessened as the brake discs are wet or even frozen (in winter). In this case the brakes should be dried by pressing the brake pedal several times.

WARNING

Longer braking distances and faults in the brake system increase the risk of accidents.

- New brake pads must be run in and do not have the correct friction during the first 200 km (120 miles). However, the reduced braking capacity may be compensated by pressing on the brake pedal a little harder. This also applies when the brake pads have to be changed further on.
- If brakes are wet or frozen, or if you are driving on roads which have been salted, braking power may be lower than normal.
- On steep slopes, if brakes are excessively used, they will overheat. Before driving down a long steep slope, it is advisable to reduce speed and change down into a lower gear or range (depending on the type of transmission). This makes use of engine braking and relieves the brakes.
- Never let the brakes “drag” by applying light pressure. Continuous braking will cause the brakes to overheat and the braking distance will increase. Apply and then release the brakes alternately.
- Never let the vehicle run with the engine switched off. The braking distance is increased considerably when the brake servo is not active.
- If the brake fluid loses its viscosity and is subjected to heavy use, vapour bubbles can form in the brake system. This reduces the efficiency of the brakes.

WARNING (Continued)

- Non-standard or damaged front spoilers could restrict the airflow to the brakes and cause them to overheat. Before purchasing accessories please observe the relevant instructions ⇒ page 190, Technical modifications.
- If a brake system circuit fails, the braking distance will be increased considerably. Contact a specialised workshop immediately and avoid unnecessary journeys.

Exhaust gas purification system

Catalytic converter*

To maintain the useful life of the catalytic converter

- Use only unleaded petrol with petrol engines, as lead damages the catalytic converter.
- Do not let the fuel get too low in the tank.
- For engine oil changes, do not replenish with too much engine oil ⇒ page 206, Topping up engine oil .
- Never tow the vehicle to start it, use jump leads if necessary ⇒ page 248.

If you notice misfiring, uneven running or loss of power when the vehicle is moving, reduce speed immediately and have the vehicle inspected at the nearest specialised workshop. In general, the exhaust gas warning lamp will light up when any of the described symptoms occur ⇒ page 65. If this happens, unburnt fuel can enter the exhaust system and escape into the environment. The catalytic converter can also be damaged by overheating. ▶

WARNING

The catalytic converter reaches very high temperatures! Risk of fire!

- Never park where the catalytic converter could come into contact with dry grass or flammable materials under the vehicle.
- Do not apply additional underseal or anti-corrosion coatings to the exhaust pipes, catalytic converter or the heat shields on the exhaust system. These materials could catch fire when the vehicle is being driven.

CAUTION

Never run the fuel tank completely dry because the irregularity of the fuel supply may cause ignition problems. This allows unburnt fuel to enter the exhaust system, which could cause overheating and damage the catalytic converter.

For the sake of the environment

Even when the emission control system is working perfectly, there may be a smell of sulphur from the exhaust gas under some conditions. This depends on the sulphur content of the fuel used. Quite often the problem can be solved by changing to another brand of fuel.

Diesel engine particulate filter*

The diesel engine particulate filter eliminates soot produced by burning diesel.

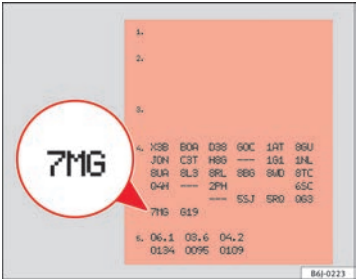

Fig. 125 Vehicle data sticker on back cover of the Maintenance Programme

Your vehicle is fitted with a DPF (Diesel particulate filter) if the vehicle data sticker (back cover of the “Maintenance Programme”) lists the PR code 7MG or 7MG ⇒ Fig. 125.

The diesel engine particulate filter eliminates most of the soot from the exhaust gas system. Under normal driving conditions, the filter cleans itself. If the driving conditions do not allow the filter to clean itself (for example, multiple short trips) the filter will be obstructed by dust and pollen and the warning lamp for the diesel engine particulate filter will light up. This does not represent a fault, it is a warning that indicates that the filter has not been able to regenerate automatically and that you must carry out a cleaning cycle, as indicated in ⇒ page 70.

**WARNING**

- The diesel engine particulate filter may reach extremely high temperatures; the vehicle should be parked so that the exhaust pipe does not come into contact with flammable materials underneath the vehicle. Otherwise there is a risk of fire.

**CAUTION**

- Your vehicle is **not** designed to use biodiesel fuel. **Never, under any circumstances** refuel with biodiesel. The use of biodiesel fuel could damage the engine and the fuel system. The addition of biodiesel to diesel by the diesel producer in accordance with standard EN 590 is authorised and will not cause damage to the engine or the fuel system.
- Using diesel fuel with a high sulphur content may significantly reduce the useful life of the diesel particulate filter. Your Technical Service will be able to tell you which countries have diesel with a high sulphur content.

Economical and environmentally friendly driving

Economical and environmentally friendly driving

Fuel consumption, environmental pollution and wear to the engine, brakes and tyres depends in large part on your driving style. By adopting an economical driving style and anticipating the traffic situation ahead, you can easily reduce fuel consumption by 10-15%. Some tips on how to help you reduce pollution while saving money are listed below.

Drive anticipating the traffic situation

A vehicle uses most fuel when accelerating. When you anticipate the situation, you have to brake less often and, thus, accelerate less. If it is possible,

let the vehicle roll with a **gear engaged**, for example, if you see a red light ahead. The braking effect achieved in this way helps to reduce the wear of brakes and tyres; emissions and fuel consumption are reduced to zero (disconnection due to inertia).

Change gear early to save energy

An effective way of saving fuel is to change up *quickly* through the gears. Running the engine at high rpm in the lower gears uses an unnecessary amount of fuel.

Manual gearbox: Change from first to second gear as quickly as possible. We recommend that, whenever possible, you change to a higher gear upon reaching 2000 rpm. Follow the “recommended gear” indication that appears on the instrument panel → page 60.

Avoid driving at high speed

We advise you not to drive at the top speed permitted by the vehicle. Fuel consumption, exhaust emissions and noise levels all increase very rapidly at higher speeds. Driving at moderate speeds will help to save fuel.

Avoid idling

It is worthwhile switching off the engine when waiting in a traffic jam, at level crossings or at traffic lights with a long red phase. The fuel saved after only 30 - 40 seconds is greater than the amount of fuel needed to restart the engine.

The engine takes a long time to warm up when it is idling. Mechanical wear and pollutant emissions are also especially high during this initial warm-up phase. It is therefore best to drive off immediately after starting the engine. Avoid running the engine at high speed.

Periodic maintenance

Periodic maintenance work guarantees that, before beginning a journey, you will not consume more than the required amount of fuel. A well-serviced engine gives you the benefit of **improved fuel efficiency** as well as maximum reliability and an enhanced resale value.

A badly serviced engine can consume up to 10% more fuel than necessary. ►

Avoid short journeys

To reduce the consumption and emission of polluting exhaust gases, the engine and the exhaust gas filtration systems should reach the optimum **service temperature**.

With the engine cold, fuel consumption is proportionally higher. The engine does not warm up and fuel consumption does not normalise until having driven approximately *four* kilometres (2.5 miles). This is why we recommend avoiding short trips whenever possible.

Maintain the correct tyre pressures

Bear in mind that keeping the tyres at an adequate pressure saves fuel. If the tyre pressure is just one bar too low, fuel consumption can increase by as much as 5%. Due to the greater rolling resistance, under-inflation also increases **tyre wear** and impairs handling.

The tyre pressures should always be checked when the tyres are *cold*.

Do not use **winter tyres** all year round as they increase fuel consumption by up to 10%.

Avoid unnecessary weight

Given that every kilo of **extra weight** will increase the fuel consumption, it is advisable to always check the luggage compartment to make sure that no unnecessary loads are being transported.

A roof rack is often left in place for the sake of convenience, even when it is no longer needed. At a speed of 100-120 km/h (60-75 mph) your vehicle will use about 12% more fuel as a result of the extra wind resistance caused by the roof rack even when it is not in use.

Save electricity

The engine activates the alternator, which produces electricity. With the need for electricity, fuel consumption is also increased. Because of this, always turn off electrical components when you do not need them. Examples of components that use a lot of electricity are: the fan at high speeds, the rear window heating or the seat heaters*.



Note

- If your vehicle has *Start-Stop*, it is not recommended to switch this function off.
- It is recommended to *close the windows* when driving at more than 60 km/h (40 mph)
- Do not drive with your foot resting *on the clutch pedal*, as the pressure can make the plate spin, more fuel will be used and it can burn the clutch plate lining, causing a serious fault.
- Do not hold the vehicle on a hill with the clutch, use the foot brake or hand brake, using the latter to start. The fuel consumption will be lower and you will prevent the clutch plate from being damaged.
- On descents, use the engine brake, changing to the gear that is more suitable for the slope. The fuel consumption will be lower and the brakes will not suffer.

Environmental friendliness

Environmental protection is a top priority in the design, choice of materials and production of your new Seat.

Design measures for economical recycling

- Joints and connections designed for easy dismantling
- Modular construction to facilitate dismantling
- Increased use of single-grade materials
- Plastic parts and elastomers are marked in accordance with ISO 1043, ISO 11469 and ISO 1629

Choice of materials

- Nearly all materials used can be recycled
- Similar types of plastics grouped together for easy recycling
- Recycled materials used in manufacture

- Reduction of volatile compounds in plastics
- CFC-free refrigerant in air conditioner

Compliance with prohibited materials regulation: cadmium, lead, mercury, chrome VI.

Manufacturing methods

- Use of recycled material for manufacturing plastic parts
- Solvent-free cavity sealing
- Solvent-free wax for protecting the vehicles in transit
- Solvent-free adhesives
- No CFCs used in production
- Surplus materials used extensively for energy conversion and building materials
- Overall water consumption reduced
- Heat recovery systems
- The use of water-soluble paints

Driving abroad

Observations

To drive abroad, the following must be taken into consideration:

- For vehicles fitted with a catalytic converter ensure that unleaded petrol is available for the journey. See the chapter "Refuelling". Automobile organisations will have information about service station networks selling unleaded fuel.
- In some countries, it is possible that your vehicle model is not sold, and therefore spare parts are not available or the Technical Services can only carry out limited repairs.

SEAT importers and distributors will gladly provide information about the technical preparations that your vehicle requires and also about necessary maintenance and repair possibilities.

Adhesive strips for headlights

If you have to drive a right-hand drive vehicle in a left-hand drive country, or vice versa, the asymmetric dipped beam headlights will dazzle oncoming traffic.

To prevent dazzling, you must apply stickers to certain parts of the headlight lenses. Further information is available at your Technical Service.

In vehicles with adaptive headlights, the rotation system must previously be disconnected. To do this, please go to a specialised workshop.

Trailer towing

What do you need to bear in mind when towing a trailer?

Your vehicle may be used to tow a trailer when fitted with the correct equipment.

If the vehicle is supplied with a **factory-fitted** towing bracket it will already have the necessary technical modifications and meet the statutory requirements for towing a trailer. If you wish to **retrofit** a towing bracket, consult → page 192.

Connectors

Your vehicle is fitted with a 12-pin connector for the electrical connection between the trailer and the vehicle.

If the trailer has a **7-pin plug** you will need to use an adapter cable. This is available in any Technical Service.

Trailer weight/drawbar load

Never exceed the authorised trailer weight. If you do not load the trailer up to the maximum permitted trailer weight, you can then climb correspondingly steeper slopes.

The maximum trailer weights listed are only applicable for **altitudes** up to 1000 m above sea level. With increasing altitude the engine power and therefore the vehicle climbing ability are impaired because of the reduced air density. The maximum trailer weight has to be reduced accordingly. The weight of the vehicle and trailer combination must be reduced by 10% for every further 1000 m (or part thereof). The gross combination weight is the actual weight of the laden vehicle plus the actual weight of the laden trailer. When possible, operate the trailer with the maximum permitted **drawbar load** on the ball joint of the towing bracket, but do not exceed the specified limit.

The figures for **trailer weights** and **drawbar loads** that are given on the data plate of the towing bracket are for certification purposes only. The correct figures for your specific model, which may be *lower* than these figures for the towing bracket, are given in the vehicle documentation or in ⇒ chapter Technical Data.

Distributing the load

Distribute loads in the trailer so that heavy objects are as near to the axle as possible. Loads carried in the trailer must be secured to prevent them moving.

Tyre pressure

Set tyre pressure to the maximum permissible pressure shown on the sticker on the inside of the fuel tank flap. Set the tyre pressure of the trailer tyres in accordance with the trailer manufacturer's recommendations.

Exterior mirrors

Check whether you can see enough of the road behind the trailer with the standard rear vision mirrors. If this is not the case, you should have additional exterior mirrors fitted. Both exterior mirrors should be mounted on hinged extension brackets. Adjust the mirrors to give sufficient vision to the rear.



WARNING

Never transport people in a trailer. This could result in fatal accidents.



Note

- Towing a trailer places additional demands on the vehicle. We recommend additional services between the normal inspection intervals if the vehicle is used frequently for towing a trailer.
- Find out whether special regulations apply to towing a trailer in your country.

Ball coupling of towing bracket*

The ball coupling is provided with instructions on fitting and removing the ball coupling of the towing bracket.



WARNING

The towing bracket ball coupling must be stored securely in the luggage compartment to prevent them being flung through the vehicle and causing injury.



Note

- By law, the ball coupling must be removed if a trailer is not being towed if it obscures the number plate.

Driving tips

Driving with a trailer always requires extra care.

Weight distribution

The weight distribution of a loaded trailer with an unladen vehicle is very unfavourable. However, if this cannot be avoided, drive extra slowly to allow for the unbalanced weight distribution.

Speed

The stability of the vehicle and trailer is reduced with increasing speed. For this reason, it is advisable not to drive at the maximum permissible speed in an unfavourable road, weather or wind conditions. This applies especially when driving downhill.

You should always reduce speed immediately if the trailer shows the slightest sign of **snaking**. Never try to stop the “snaking” by increasing speed.

Always brake in due course. If the trailer has an **overrun brake**, apply the brakes *gently at first* and then, firmly. This will prevent the jerking that can be caused by locking of trailer wheels. Select a low gear in due course before going down a steep downhill. This enables you to use the engine braking to slow down the vehicle.

Reheating

At very high temperatures and during prolonged slopes, driving in a low gear and high engine speed, always monitor the coolant temperature gauge
⇒ page 55.

Electronic Stability Control*

The ESC* system helps to stabilise the trailer in case of skidding or rocking. ■

Vehicle maintenance and cleaning

General notes

Regular washing and care help maintain the value of your vehicle.

Vehicle maintenance

Regular care and washing help to **maintain the value** of the vehicle. This may also be one of the requirements for acknowledging warranty claims in the event of bodywork corrosion or paint defects.

The best way to protect your vehicle against the harmful effects of the environment is through correct maintenance and *frequent* washing. The longer substances such as insect remains, bird droppings, resinous tree sap, road dirt, industrial deposits, tar, soot or road salt and other aggressive materials remain on the vehicle, the more damage they do to the paintwork. High temperatures (for instance in strong sunlight) further intensify the corrosive effect.

After winter, a period when salt is put on the roads, it is important to have the **underside** of the vehicle washed thoroughly.

Products for vehicle maintenance

Car-care products are available in your Technical Services. Keep the product instructions until you have used them up.



WARNING

- Car-care products can be toxic. Because of this, they must always be kept closed in their original container. Keep them out of the reach of children. Failure to comply could result in poisoning.
- Always read and observe the instructions and warnings on the package before using car-care products. Improper use could cause health problems or damage the vehicle. The use of certain products may produce noxious vapours; they should be used in well ventilated areas.
- Never use fuel, turpentine, engine oil, nail varnish remover or other volatile fluids. These are toxic and highly flammable. Risk of fire and explosion.
- Before washing your vehicle, or carrying out any maintenance, switch the engine off, apply the handbrake firmly and remove the key from the ignition.



CAUTION

Never attempt to remove dirt, mud or dust if the surface of the vehicle is dry. Never use a dry cloth or sponge for cleaning purposes. This could damage the paintwork or the windows of your vehicle. Soak dirt, mud or dust with plenty of water.



For the sake of the environment

- When purchasing products for your vehicle maintenance, select the ones which are not harmful to the environment.
- The waste from car-care products should not be disposed of with ordinary household waste. Observe the disposal information on the package. ■

Care of the vehicle exterior

Automatic car washing tunnel

The vehicle paintwork is so durable that the vehicle can normally be washed without problems in an automatic car wash tunnel. However, the paintwork wear depends to a large extent on the kind of the car wash tunnel, the brushes used, its water filtering and the type of cleaning and preservative products.

Before going through a car wash, be sure to take the usual precautions such as closing the windows and sunroof. There is nothing to note apart from that.

If the vehicle has special accessories such as spoilers or a roof rack or two-way radio aerial, etc., it is advisable to consult the car wash tunnel operator.

After washing, the **brakes** could take some time to respond as the brake discs and pads could be wet, or even frozen in winter. Dry the brakes by braking several times.



WARNING

Water, ice and salt on the brake system can reduce braking effectiveness. Risk of accident.



CAUTION

Before putting the vehicle through the car washing tunnel, do not tighten the aerial if it is folded because it can be damaged. ■

Washing by hand

Vehicle washing

- First soften the dirt and rinse it off with water.
- Clean your vehicle from top to bottom with a soft sponge, a glove or a brush. Use very light pressure.
- Rinse the sponge or glove often with clean water.
- Special car shampoo should only be used for very stubborn dirt.
- Leave the wheels, sill panels etc. until last, using a different sponge or glove.
- Rinse the vehicle thoroughly with water.
- Dry the vehicle surface gently with a chamois leather.
- In **cold temperature**, dry the rubber seals and their surfaces to prevent them from freezing. Apply silicone spray to the rubber seals.

After washing the vehicle

- After washing, avoid sudden and sharp braking. Dry the brakes by braking several times. ►

**WARNING**

- Wash your vehicle with the ignition switched off.
- Protect your hands and arms from cuts on sharp metal edges when cleaning the underbody, the inside of the wheel housings etc. Risk of injury.
- Water, ice and salt on the brake system can reduce braking effectiveness. Risk of accident.

**CAUTION**

- Never remove dirt, mud or dust if the vehicle surface is dry. Never use a dry cloth or sponge for cleaning purposes. This could scratch the paintwork or glass on your vehicle.
- Washing the vehicle in low temperatures: when washing the vehicle with a hose, do not direct water into the lock cylinders or the gaps around the doors, rear lid, or sunroof. Risk of freezing.

**For the sake of the environment**

To protect environment, the vehicle should be washed only in specially provided wash bays. This prevents toxic, oil-laden waste water entering the sewerage system. In some places, washing vehicles outside wash bays is prohibited.

**Note**

Do not wash the vehicle in direct sunlight.

Washing the vehicle with a high pressure cleaner

Be particularly careful when using a high pressure cleaner!

- Always observe the instructions for the high-pressure cleaner, particularly those concerning the **pressure** and the **spraying distance**.
- Increase the spraying distance for soft materials and painted bumpers.
- Do not use a high pressure cleaner to remove ice or snow from windows ⇒ page 184.
- Never use concentrated jet nozzles (“rotating jets”) ⇒
- After washing, avoid sudden and sharp braking. “Dry” the brakes by braking several times ⇒ page 173.

**WARNING**

- Never wash tyres with a concentrated jet (“rotating nozzle”). Even at large spraying distances and short cleaning times, visible and invisible damage can occur to the tyres. This may cause an accident.
- Water, ice and salt on the brake system can reduce braking effectiveness. Risk of accident.

**CAUTION**

- Do not use water hotter than 60°C. This could damage the vehicle.
- To avoid damage to the vehicle, keep a sufficient distance from sensitive materials such as flexible hoses, plastic, soundproofing material, etc. This is also important for bumpers painted in the colour of the bodywork. The closer the nozzle is to the surface, the greater the wear on the material.

Vehicle paint maintenance

Regular waxing protects the paintwork.

You need to apply wax to your vehicle if water does not form small drops and run off the paintwork when it is *clean*.

Good quality *hard wax* products are available at your Technical Service.

Regular wax applications help to protect the paintwork from environmental contaminants ⇒ page 181. It is also effective in protecting against minor scratches.

Even if a **wax solution** is used regularly in the vehicle washing tunnel, it is advisable to protect the paint with a hard wax coating at least twice a year. ■

Polishing the paintwork

Polishing brings back gloss to the paintwork.

Polishing is only necessary if the paint has lost its shine, and the gloss cannot be brought back by applying wax. Polishing products can be purchased in your Technical Service.

The vehicle must be waxed after polishing if the polish used does not contain wax compounds to seal the paint ⇒ page 184, Vehicle paint maintenance.



CAUTION

To prevent damage to the paintwork:

- Do not use polishes and hard wax on painted parts with a matt finish or on plastic parts.
- Do not polish your vehicle in a sandy or dusty environment. ■

Caring for plastic parts

Solvents damage plastic parts.

If normal washing fails to clean plastic parts, clean them with approved **solvent-free** plastic cleaning and care products.



CAUTION

- The use of liquid air freshener directly over the air vents of the vehicle may damage the plastic parts if the liquid is accidentally spilled.
- Cleaning products which contain solvents will damage the material. ■

Cleaning windows and exterior mirrors

Cleaning windows

- Moisten the windows with commercially available, alcohol based glass cleaner.
- Dry the windows with a clean chamois leather or a lint-free cloth.

Removing snow

- Use a small brush to remove snow from the windows and mirrors.

Removing ice

- Use a de-icer spray.

Use a clean cloth or chamois leather to dry the windows. The chamois leathers used on painted surfaces are not suitable to clean windows because they are soiled with wax deposits which could smear the windows. ▶

If possible, use a de-icing spray to remove ice. If you use an ice scraper, push it in one direction only without swinging it.

Use window cleaner or a silicone remover to clean rubber, oil, grease and silicone deposits off.

Wax deposits can be removed with a special cleaner available in your Technical Services. Wax deposits on the windscreen could cause the wiper blades to judder. Adding a window cleaner that dissolves wax to the windscreen washer fluid prevents wiper blades from juddering, but wax deposits are not removed.



CAUTION

- Never use warm or hot water to remove snow and ice from windows and mirrors. This could cause the glass to crack!
- The heating element for the rear window is located on the inner side of the window. To prevent damage, do not put stickers over the heating elements on the inside of the window.

Cleaning windscreen wiper blades

Clean wiper blades improve visibility.

1. Use a soft cloth to remove dust and dirt from the windscreen wiper blades.
2. Use window cleaner to clean the windscreen wiper blades. Use a sponge or a cloth to remove stubborn dirt.

Rubber seals maintenance

If rubber seals are well looked after, they will not freeze so quickly.

1. Use a soft cloth to remove dust and dirt from the rubber seals.
2. Apply a specialist care product to the rubber seals.

The rubber strips on the doors, windows, bonnet and rear lid will remain pliable and last longer if they are treated with a suitable care product (for example silicone spray).

Caring for rubber seals will also prevent premature ageing and leaks. The doors will be easier to open. If rubber seals are well looked after, they will not freeze so quickly in winter.

Door lock cylinders

The door lock cylinders can freeze up in winter.

To de-ice the lock cylinders you should only use spray with lubricating and anti-corrosive properties.

Cleaning chrome parts

1. Clean chrome parts with a damp cloth.
2. Polish chrome parts with a soft, dry cloth.

If this does not provide satisfying results, use a specialist **chrome cleaning product**. Chrome cleaning products will remove stains from the surface.

**CAUTION**

To prevent scratching chrome surfaces:

- Never use an abrasive cleaning product on chrome.
- Do not clean or polish chrome parts in a sandy or dusty environment. ■

Steel wheel rims

- Clean steel wheel rims regularly using a separate sponge.

Use an industrial cleaner to remove brake dust. Any damage to the paint on steel wheel rims should be repaired before starting to rust.

**WARNING**

- **Never wash tyres with a cylindrical jet. Even at large spraying distances and short cleaning times, visible and invisible damage can occur to the tyres. This may cause an accident.**
- **Water, ice and salt on the brake system can reduce braking effectiveness. Risk of accident. Directly after washing, avoid sudden and sharp braking. Dry the brakes by braking several times ⇒ page 173, Braking capacity and braking distance.** ■

Alloy wheel rims**Every two weeks**

- Wash salt and brake dust from alloy wheels.
- Use an acid free detergent to clean the wheel rims.

Every three months

- Apply a hard wax compound to the wheels.

Alloy wheels require regular attention to preserve their appearance. If road salt and brake dust are not often removed, the aluminium finish will be impaired.

Always use an acid-free detergent for alloy wheel rims.

Car polish or other abrasive agents should not be used for maintaining the rims. If the protective coating is damaged, e.g. by flying stones, the damaged area should be repaired immediately.

**WARNING**

- **Never wash tyres with a cylindrical jet. Even at large spraying distances and short cleaning times, visible and invisible damage can occur to the tyres. This may cause an accident.**
- **Water, ice and salt on the brake system can reduce braking effectiveness. Risk of accident. Directly after washing, avoid sudden and sharp braking. Dry the brakes by braking several times ⇒ page 173, Braking capacity and braking distance.** ■

Underbody protection

The vehicle underbody is coated to protect it from chemical and mechanical damage.

The protective coating can be damaged when driving. We recommend you to check the protective coating under the body and on the running gear, and reinstated if necessary, before and after the winter season.

We recommend you to go to your Technical Service to carry out repair work and additional anti-corrosion work. ▶

 **WARNING**

Do not apply underseal or anti-corrosion coatings to the exhaust pipes, catalytic converter or the heat shields on the exhaust system. The heat of the exhaust system or the engine could cause them to ignite. Risk of fire. ■

Cleaning the engine compartment

Take special care when cleaning the engine compartment.

Anti-corrosion treatment

The engine compartment and the surface of the power unit are given anti-corrosion treatment at the factory.

Good corrosion protection is particularly important in winter when the vehicle is frequently driven on salted roads. To prevent the salt corroding the vehicle, the entire engine compartment should be thoroughly cleaned before and after winter.

Your Technical Services have got the necessary workshop equipment to provide the correct cleaning and preserving products. For this reason, we recommend having this work performed by them.

The anti-corrosion protection is usually removed if the engine compartment is cleaned with grease removing solutions, or if you have the engine cleaned. On commissioning this work, ensure that all surfaces, seams, joints and components in the engine compartment are given anti-corrosion treatment.

 **WARNING**

- When working in the engine compartment, always observe the safety warnings → page 200.
- Before opening the bonnet, switch the engine off, apply the hand-brake firmly and always remove the key from the ignition.
- Allow the engine to cool before you clean the engine compartment.
- Do not clean the vehicle underbody, wheel arches or wheel trims without protecting your hands and arms. You may cut yourself on sharp-edged metal parts. Failure to comply could result in injury.
- Moisture, ice and salt on the brake system may affect braking effectiveness. Risk of accident. Directly after washing, avoid sudden and sharp braking.
- Never touch the radiator fan. It is temperature-controlled and could start automatically, even when the key is removed from the ignition!



For the sake of the environment

Fuel, grease and oil deposits could be removed when the engine is washed. The polluted water must be cleaned in an oil separator. For this reason, engine washing should be carried out only by a specialised workshop or a petrol station. ■

Vehicle interior maintenance

Plastic parts and dash panel cleaning

- Use a clean, damp cloth to clean plastic parts and the dash panel.
- If this does not provide satisfactory results, use a special **solvent-free** plastic cleaning product. ▶

**WARNING**

Never clean the dash panel and the airbag module surface with cleaners containing solvents. Solvents cause the surface to become porous. If the airbag triggered, plastic parts could become detached and cause injuries.

**CAUTION**

Cleaning products which contain solvents will damage the material.

Wooden trim cleaning*

- Clean the wooden trim with a water-moistened clean cloth.
- If this does not provide satisfactory results, use a *gentle* soap solution.

**CAUTION**

Cleaning products which contain solvents will damage the material.

Cloth seat covers and fabric trim cleaning

Cloth seat covers and fabric trim on the doors, headlining etc. can be cleaned with a special interior cleaner or with dry foam and a soft brush.

Cleaning the radio and climate controls

To clean the radio and/or climate controls, use a soft damp cloth. For more resistant dirt, a neutral soap solution may be used. ■

Leather cleaning***Normal cleaning**

- Moisten a cotton or woollen cloth with water and wipe over the leather surfaces.

Cleaning stubborn stains

- More stubborn dirt can be removed using a mild soap solution (pure liquid soap; two tablespoons diluted in one litre of water) and a cloth.
- Do not let the water soak through the leather or soak into the seams.
- Then wipe off with a soft, dry cloth.

Leather maintenance

- The leather should be treated twice a year with a special leather-care product, available in your Technical Services.
- Apply these products very sparingly.
- Then wipe off with a soft, dry cloth.

SEAT does everything possible to preserve the genuine qualities of this natural product. Due to the natural properties of the specially selected hides employed, the finished leather has a certain sensitivity to grease and dirt, ►

etc. so a degree of care is required in everyday use and when looking after the leather.

Dust and grit in the pores and seams can scratch and damage the surface. If the vehicle is under solar radiation for long periods, the leather should be protected to prevent it from fading. However, slight colour variations in high-quality natural leather are normal.



CAUTION

- Do not use solvents, wax polish, shoe cream, spot removers or similar products on leather.
- To avoid damage, stubborn stains should be removed by a specialised workshop.

Seat belt cleaning

A dirty belt may not work properly.

Check all seat belts regularly and keep them clean.

Seat belt cleaning

- Pull the dirty seat belt right out and unroll it.
- Clean dirty seat belts with a *gentle* soap solution.
- Allow it to dry.
- Do not roll the seat belt up until it is dry.

If large stains form on the belts, it will not retract correctly into the automatic belt retractor.



WARNING

- Do not use chemical cleaning agents on the seat belts, as this can impair the strength of the webbing. Ensure that seat belts do not come into contact with corrosive fluids.
- Check the condition of the seat belts at regular intervals. If you notice that the belt webbing, fittings, retractor mechanism or buckle of any of the belts is damaged, the belt must be replaced by a specialised workshop.
- Do not attempt to repair a damaged seat belt yourself. The seat belts must not be removed or modified in any way.



CAUTION

After cleaning, allow seat belts to dry completely before rolling them up. Otherwise, the belt retractors could become damaged.

Accessories, replacement of parts and modifications

Accessories and spare parts

Always consult a SEAT dealership before purchasing accessories and parts.

Your vehicle is designed to offer a high standard of active and passive safety.

Before purchasing accessories and parts, and before making technical changes to your vehicle, we recommend you to consult your SEAT Technical Service.

SEAT dealerships will be happy to provide you with the latest information about the use, legal requirements and recommendations from the manufacturer regarding accessories and parts.

We recommend you use only **SEAT Approved Accessories®** and **SEAT Approved Spare Parts®**. This way, SEAT can guarantee that the product in question is suitable, reliable and safe. SEAT Technical Services have the necessary experience and facilities to ensure that parts are correctly and professionally installed.

Despite a continuous observation of the market, SEAT is not able to assess the reliability, safety and suitability of those parts **SEAT has not approved**. For this reason, SEAT cannot assume responsibility for any non-genuine parts used, even if these parts have been approved by an official testing agency or are covered by an official approval certificate.

Any **equipment subsequently installed** which has a direct effect on the driver's control of the vehicle (e.g. cruise control system or electronically-controlled suspension) must be approved by SEAT and bear the **e** mark (the European Union's authorisation symbol).

If any **additional electrical components** are fitted which do not serve to control the vehicle itself (e.g. refrigerator box, laptop or ventilator fan), these must bear the **CE** mark (European Union manufacturer conformity declaration).



WARNING

Accessories, for example telephone holders or cup holders, should never be fitted on the covers, or within the working range, of the airbags. Otherwise, there is a danger of injury if the airbag is triggered in an accident.

Technical modifications

Modifications must always be carried out according to our specifications.

Unauthorised modifications to the electronic components or software in the vehicle may cause malfunctions. Due to the way the electronic components are linked together in networks, other indirect systems may be affected by the faults. This can seriously impair safety, lead to excessive wear of components, and also invalidate your vehicle registration documents.

The SEAT Technical Service cannot be held liable for any damage caused by modifications and/or work incorrectly performed.

For this reason, we recommend having all work performed by a SEAT Technical Service using **SEAT Original Spare Parts®**.

⚠ WARNING

Incorrectly performed modifications or other kind of work on your vehicle can lead to malfunctions and cause accidents.

Roof aerial*

The vehicle can be fitted with a foldable* and anti-theft* roof aerial, which can be folded backwards, when, for example, going through an automatic carwash.

To fold

Unscrew the aerial rod, tilting it backwards into a horizontal position and then screw in again.

To return to working position

Continue in the reverse order to the previous instruction.

**CAUTION**

If an automatic car wash tunnel is used, before entering the tunnel, put the aerial down parallel to the roof and do not tighten to avoid damage.

Mobile telephones and two-way radios

You will require an external aerial for mobile phones and two-way radios.

SEAT has approved for your vehicle the use of mobile telephones and two-way radios providing under the following conditions:

- The correct installation of an external aerial,
- transmitting power of maximum 10 watts.

The optimal reach of the equipment is only achieved with an external aerial.

First consult your Technical Service if you wish to use a mobile telephone or a two-way radio with a transmitting power output in excess of 10 watts. Here you will receive information concerning the technical possibilities for retrofitting this equipment.

Mobile telephones and two-way radios should be only fitted by a specialised workshop, for example a SEAT dealership.

**WARNING**

- **Always concentrate primarily on driving. If you are distracted while driving you could have an accident.**
- **Never attach the telephone mountings to the surfaces covering the airbag units or within the range of the airbags. There is a high danger of injury if the airbag is triggered.**
- **Using your mobile telephones or two-way radios in the vehicle without an external aerial, electromagnetic radiation in the vehicle could exceed authorised limits. This also may occur to external aerials that have not been correctly installed.**

**CAUTION**

Failure to consider the above-mentioned conditions could cause the electronics to malfunction. The most common causes of faults are:

- no external aerial,
- external aerial incorrectly installed,
- transmitting power output in excess of 10 watts.

**Note**

Please observe the operating instructions of your mobile telephone/two-way radio.

Fitting a towing bracket*

It is possible to fit a towing bracket to the rear of the vehicle.

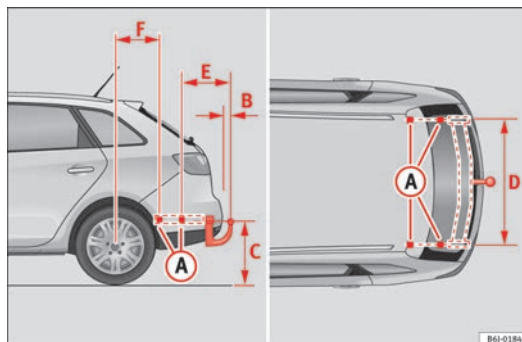

Fig. 126 Attachment points for towing bracket

If a towing bracket is to be fitted after the vehicle is purchased, this must be completed according to the instructions of the towing bracket manufacturer.

The attachment points for the towing bracket (A) are on the lower part of the vehicle.

The distance between the centre of the ball coupling and the ground should never be lower than the indicated value, even with a fully loaded vehicle and including the maximum drawbar load.

Elevation values for securing the towing bracket:

- (B) 65 mm (minimum)
- (C) from 350 mm to 420 mm (fully loaded vehicle)
- (D) 959 mm
- (E) 379 mm
- (F) 386 mm

Fitting a towing bracket

- Driving with a trailer involves an extra effort for the vehicle. Therefore, before fitting a towing bracket, please contact a Technical Service to check whether your cooling system needs modification.
- The legal requirements in your country must be observed (e.g. the fitting of a separate control lamp).
- Certain vehicle components, e.g. the rear bumper, must be removed and reinstalled. The towing bracket securing bolts must be tightened using a torque wrench, and a power socket must be connected to the vehicle electrical system. This requires specialised knowledge and tools.
- Figures in the illustration show the elevation value and the attachment points which must be considered if you are retrofitting a towing bracket.

**WARNING**

The towing brackets should be fitted at a specialised workshop.

- If the towing bracket is incorrectly installed, there is a serious danger of accident.
- For your own safety, please observe the instructions provided by the manufacturer of the towing bracket.

**CAUTION**

- If the power socket is incorrectly installed, this could cause damage to the vehicle electrical system.

**Note**

- SEAT recommends that the towing hooks be fitted at a specialised workshop. In certain versions this may entail fitting a heat insulating plate, which is why it is recommended that you go to a SEAT dealership. In the event that the plate is not installed correctly, SEAT is exempt from any liability.
- Due to the specific design of the exhaust, the fitting of a conventional towing hook is not recommended for some sportier versions. Please consult your Technical Service. ■

Checking and refilling levels

Refuelling

The tank flap is released manually. The tank holds approximately 45 litres.

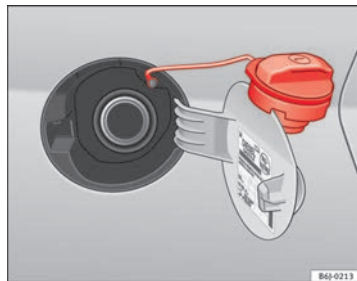

Fig. 127 Tank flap open

Opening the fuel tank cap

- Lift the lid.
- Hold the cap firmly with one hand, then insert the key into the lock and rotate 180° to the left.
- Unscrew the cap, turning it anticlockwise.

Closing the fuel tank cap

- Screw the tank cap to the right, until the point of feeling a “click”.

- Turn the key in the lock, without releasing the cap, clockwise through 180°.
- Remove the key and close the flap until it clicks into place. The tank cap is secured with an anti-loss attachment

The tank flap is at the rear of the vehicle on the right.

If the automatic filler nozzle is operated correctly, it will switch itself off as soon as the fuel tank is “full”. Never attempt to fill beyond this point, as this will fill the expansion chamber. Fuel may leak out if ambient conditions are warm.

The correct fuel grade for your vehicle is given on a sticker on the inside of the fuel tank flap. ▶

**WARNING**

- Fuel is highly flammable and can cause serious burns and other injuries.
 - Never smoke or use an open flame when filling the fuel tank of the vehicle, or a spare fuel canister, with fuel. This is an explosion hazard.
 - Follow legal requirements for the use of spare fuel canisters.
 - For safety reasons we do not recommend carrying a spare fuel canister in the vehicle. The canister could be damaged in an accident and leak.
- If, in exceptional circumstances, you have to carry a spare fuel canister, please observe the following points:
 - Never fill the spare fuel canister inside the vehicle or on it. An electrostatic charge could build up during filling, causing the fuel fumes to ignite. This could cause an explosion. Always place the canister on the ground to fill it.
 - Insert the fuel nozzle into the mouth of the canister as far as possible.
 - If the spare fuel canister is made of metal, the filling nozzle must be in contact with the canister during filling. This helps prevent an electrostatic charge building up.
 - Never spill fuel in the vehicle or in the luggage compartment. Fuel vapours are explosive. Danger of death.

**CAUTION**

- Fuel spills should be removed from the paintwork immediately.
- Never run the tank completely dry. An irregular fuel supply could cause misfiring. As a result, unburnt fuel could enter the catalytic converter and cause damage.
- When filling the fuel tank after having run it completely dry on a vehicle with a **diesel engine** the ignition must be switched on for at least 30 seconds without starting the engine. When you then start the engine it may

take longer than normal (up to one minute) for the engine to start firing. This is due to the fact that the fuel system has to purge itself of air before starting.

**For the sake of the environment**

Do not try to put in more fuel after the automatic filler nozzle has switched off; this may cause the fuel to overflow if it becomes warm. ■

LPG system*

Refuelling with LPG

The LPG filler neck is behind the fuel cap, next to the petrol filler neck.

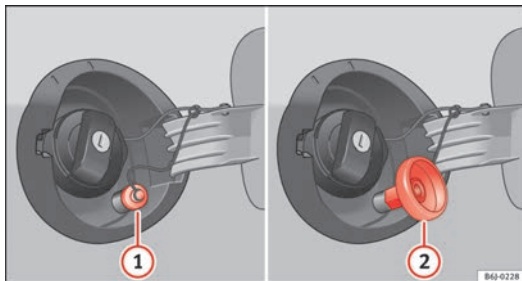

Fig. 128 Fuel tank open with LPG filler neck and adapter.

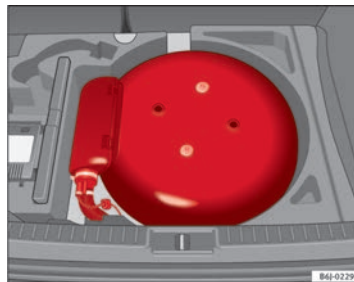

Fig. 129 LPG tank in spare wheel well

Refuelling with LPG

- **Before** refuelling, stop the engine and switch off the ignition.
- Open the tank flap.
- **Before** refuelling, please read the instructions on the pump.
- Unscrew the cap of the gas filler neck ⇒ Fig. 128 ①.
- Screw the required adapter ⇒ Fig. 128 ② on the gas filler neck ①.
- Refuel as indicated in the instructions on the pump.
- Unscrew the adapter ⇒ Fig. 128 ②.
- Screw on the cap of the gas filler neck ⇒ Fig. 128 ①.
- Close the tank flap.

When the hose is removed from the tank, a small amount of LPG may spill out ⇒ ⚠

The LPG tank ⇒ Fig. 129 in the spare wheel well has a capacity of 52.8 litres. If the outside temperatures are very low, it may not be possible to completely fill the LPG tank.

Pump attachments

There are a variety of types of LPG pump, and the methods of use may vary. Therefore, let the pump operator fill the tank when refuelling for the first time or fill from another pump.

Noises when refuelling with LPG

When refuelling with LPG, noises may be heard. These noises are insignificant.

WARNING

Failure to refuel or handle LPG in the correct way could result in a fire, cause an explosion or lead to injuries.

- LPG is a highly explosive and inflammable substance. It may cause severe burns and other injury.
- Switch off the engine before refuelling.
- Always switch off mobile phones and any other radiophony appliances, as electromagnetic waves may produce sparks and cause a fire.
- Do not remain in the vehicle while refuelling. If it is absolutely necessary to enter the vehicle, close the door and touch a metal surface before touching the attachment again. This will prevent the generation of static electricity and any possible fires while refuelling.
- Small quantities of LPG may leak out after refuelling. If LPG comes in contact with skin, there is a risk of freezing.
- Do not smoke and always keep bare flames away from the tank during refuelling. Failure to do so may lead to an explosion.

Adapter for the liquid petroleum gas (LPG) filler neck

An adapter is required due to the existence of a range of pumps with different nozzles.

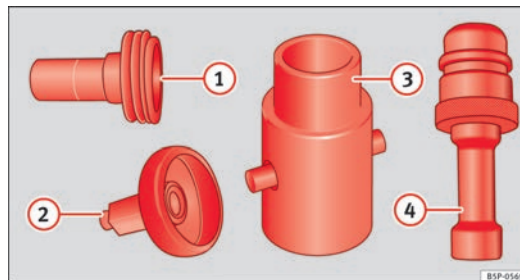

Fig. 130 General table of LPG filler neck adapters.

- ① ACME adapter (adapter for Europe)
- ② Dish Coupling Adapter (adapter for Italy)
- ③ Bayonet adapter
- ④ EURO adapter (adapter for Spain)

The supply includes the adapter for the country in question, the ACME ①, the Dish Coupling ②, the bayonet ③ or the EURO adapter ④.

The filler systems and corresponding adapters vary according to country. As petrol stations abroad do not always have the necessary adapters for your LPG system, we recommend you purchase the appropriate adapter before travelling abroad. Check that the adapters are suited to your filling system. ►

**Note**

The four most common types of adapter in Europe are the ACME adapter (1), the Dish Coupling adapter (2), the bayonet adapter (3) and the EURO adapter (4). On the whole, we recommend you carry all four adapters in your vehicle, as some countries use more than one type of filling system. The introduction of a single system (Euronozzle) throughout Europe is being studied. ■

LPG fuel

LPG is an alternative vehicle fuel and is a blend of propane and butane.

The success of LPG is due to the strict regulations concerning exhaust gas emissions. Compared to other fossil fuels, LPG is characterised by its reduced emissions.

LPG quality and consumption

Quality requirements for LPG are regulated for all Europe in DIN EN 589 and permit the use of LPG throughout Europe.

A difference is drawn between winter gas and summer gas. Winter gas has a higher proportion of propane gas. As a result, the driving range of winter gas may be lower (due to increased consumption) than that of summer gas.

LPG supplier network

The number of LPG pumps is constantly increasing.

Lists of existing LPG pumps may be found on Internet. ■

LPG safety

A series of collision tests performed on this vehicle while running with LPG have confirmed its high level of safety.

The safety of the LPG system guarantees operation without risk. The following safety measures have been adopted:

- The LPG tank has a solenoid valve which closes automatically when the engine is switched off (ignition off) or when running on petrol.
- A solenoid type main valve disconnects the supply of gas to the engine compartment when the engine is switched off or running on petrol.
- A safety valve in the LPG tank with pipes to the outside prevents the gas from entering the vehicle interior.
- All anchorage points and materials have been designed to ensure the maximum possible levels of safety.

The condition of the LPG system should be checked regularly to guarantee safe driving conditions → ⚠. These checks are included in the Maintenance Programme.

**WARNING**

- **If there is a smell of gas or a suspected leak, stop the vehicle immediately and switch off the ignition. Open the doors to ventilate the vehicle. Do not carry on driving! Take the vehicle to a specialised workshop and have the fault repaired.**
- **Immediately extinguish any cigarettes and remove from the vehicle any objects which might produce a spark or cause a fire, and switch off immediately if gas is smelt or a leak is detected.**
- **LPG tanks are subject to pressure and must be checked regularly. The owner of the vehicle must check that these services are performed correctly.**
- **When parking the vehicle in a closed area (for example in a garage), make sure that there is adequate ventilation, either natural or mechanical, to neutralise the LPG in the event of a leak.**

**Note**

For any fault in the LPG system, please refer to the SEAT web page, which lists the workshops authorised to repair these faults. ■

Petrol

Petrol types

The correct petrol types are listed on a sticker inside the fuel tank flap.

Only **unleaded petrol conforming to standard DIN EN 228** may be used for vehicles with catalytic converters (EN = "European Standard").

Fuel types are differentiated by the **octane rating**, e.g: 91, 95, 98 RON (RON = "Research Octane Number", unit for determining the knock resistance of petrol). You may use petrol with a higher octane number than the one recommended for your engine. However, this has no advantage in terms of fuel consumption and engine power.



CAUTION

- Even one tankful of leaded fuel would permanently impair the efficiency of the catalytic converter.
- High engine speed and full throttle can damage the engine when using petrol with an octane rating lower than the correct grade for the engine.



For the sake of the environment

Just one full tank of leaded fuel would seriously impair the efficiency of the catalytic converter.

Petrol additives

Petrol additives improve the quality of the petrol.

The quality of the petrol influences the performance, power and life of the engine. For this reason, you should use good quality petrol containing addi-

tives. These additives will help to prevent corrosion, keep the fuel system clean and prevent deposits from building up in the engine.

If good quality petrol with additives is not available or engine problems occur, the required additives must be added during refuelling.

Diesel

Diesel*

Diesel fuel must conform to DIN EN 590 (EN = "European Standard"). It must have a cetane number (CN) of at least 51. The cetane number indicates the ignition quality of the diesel fuel.

Notes on refuelling ⇒ page 194.

Biodiesel*



CAUTION

- Your vehicle is **not** designed to use biodiesel fuel. **Never, under any circumstances** refuel with biodiesel. The use of biodiesel fuel could damage the engine and the fuel system. The addition of biodiesel to diesel fuel by the diesel manufacturer in accordance with standard EN 590 or DIN 51628 is authorised and will not cause damage to the engine or the fuel system.
- The diesel engine has been designed to be used exclusively with diesel fuel conforming to standard EN 590. **Never** refuel or use petrol, kerosene, fuel oil or any other type of fuel. If you accidentally fill up the vehicle with the wrong type of fuel, do not start the engine. Seek assistance from specialised personnel. The composition of these fuels may severely damage the fuel system and the engine.

Winter driving

Diesel can thicken in winter.

Winter-grade diesel

When using “summer-grade diesel fuel”, difficulties may be experienced at temperatures below 0°C because the fuel thickens due to wax separation. Therefore, “winter-grade diesel fuel” is available in some countries during the cold months. It can be used at temperatures as low as -22°C.

In countries with different climatic conditions the diesel fuel generally sold has different temperature characteristics. Check with the Technical Services or filling stations in the country concerned regarding the type of diesel fuels available.

Filter pre-heater

Your vehicle is fitted with a fuel filter glow plug system, making it well equipped for operation in winter. This ensures that the fuel system remains operational to approx. -24°C, provided you use winter-grade diesel which is safe to -15°C.

However, if the fuel has waxed to such an extent that the engine will not start at temperatures of under -24°C, simply place the vehicle in a warm place for a while.



CAUTION

Do not mix fuel additives (thinners or similar products) with diesel fuel.

Working in the engine compartment

Safety instructions on working in the engine compartment

Any work carried out in the engine compartment or on the engine must be carried out cautiously.

Before starting any work on the engine or in the engine compartment:

1. Switch off the engine and remove the key from the ignition.
2. Apply the handbrake.
3. Move the gear lever to neutral or the selector lever to position P.
4. Wait for the engine to cool down.
5. Keep children away from the vehicle.
6. Raise the bonnet ⇒ page 202.

You should not do any work in the engine compartment unless you know exactly how to carry out the jobs and have the correct tools! Have the work carried out by a specialised workshop if you are uncertain.

■ All service fluids and consumables, e.g. coolant, engine oil, spark plugs and batteries, are under constant development. SEAT provides a constant flow of information to the Technical Services concerning modifications. For this reason, we recommend you to have service fluids and consumables replaced by a Technical Service. Please observe the relevant instructions ⇒ page 190. The engine compartment of the vehicle is a hazardous area. ⇒ ⚠

**WARNING**

All work on the engine or in the engine compartment, e.g. checking and refilling fluids, involves the danger of injury and scalding as well as the risk of accident or fire.

- Never open the bonnet if you see steam, smoke or coolant escaping from the engine compartment. Otherwise, there is a risk of sustaining burns. Wait until no more steam or coolant is emitted, then allow the engine to cool before carefully opening the bonnet.
- Switch off the engine and remove the key from the ignition.
- Apply the handbrake and move the gear lever to neutral or selector lever to position P.
- Keep children away from the vehicle.
- Never touch hot engine parts. There is a risk of burns.
- Never spill liquids on a hot engine or on a hot exhaust gas system. This is a fire hazard.
- Avoid causing short-circuits in the electrical system, particularly at the points where the jump leads are attached ⇒ page 249. The battery could explode.
- Never touch the radiator fan. It is temperature controlled and could start automatically, even when the engine has been switched off and the key removed from the ignition!
- Do not unscrew the cap on the coolant expansion tank when the engine is hot. If the coolant is hot, the cooling system will be pressurised!
- Protect face, hands and arms by covering the cap with a large, thick cloth to protect against escaping coolant and steam.
- Always make sure you have not left any objects, such as cleaning cloths and tools, in the engine compartment.
- If you have to work underneath the vehicle, you must use suitable stands additionally to support the vehicle, there is a risk of accident!. A hydraulic jack is insufficient for securing the vehicle and there is a risk of injury.

**WARNING (Continued)**

- If any work has to be performed when the engine is started or with the engine running, there is an additional, potentially fatal, safety risk from the rotating parts, such as the drive belts, alternator, radiator fan, etc., and from the high-voltage ignition system. You should also observe the following points:
 - Never touch the electrical wiring of the ignition system.
 - Ensure that jewellery, loose clothing and long hair do not get trapped in rotating engine parts. Danger of death. Before starting any work remove jewellery, tie back and cover hair, and wear tight-fitting clothes.
 - Never accelerate with a gear engaged without taking the necessary precautions. The vehicle could move, even if the handbrake is applied. Danger of death.
- If work has to be carried out on the fuel system or on electrical components, you must observe the following safety notes in addition to the above warnings:
 - Always disconnect the battery from the on-board network. The vehicle must be unlocked when this is done, otherwise the alarm will be triggered.
 - Do not smoke.
 - Never work near naked flames.
 - Always have a fire extinguisher on hand.

**CAUTION**

When topping up service fluids, make sure not to mistake them. Using the wrong fluids could cause serious malfunctions and engine damage! ▶



For the sake of the environment

Service fluids leaks are harmful to the environment. For this reason you should make regular checks on the ground underneath your vehicle. If you find spots of oil or other fluids, have your vehicle inspected in a specialised workshop.

Opening the bonnet

The bonnet is released from inside the vehicle.



Fig. 131 Bonnet opening lever

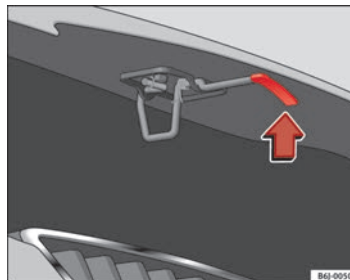

Fig. 132 Bonnet support rod

Before opening the bonnet ensure that the windscreen wipers are in rest position.

- To release the bonnet, pull the lever under the dash panel ⇒ Fig. 131 in the direction indicated (arrow). The bonnet will be released by a spring action ⇒ ⚠.
- Lift the bonnet using the release lever (arrow) and open the bonnet.
- Release the bonnet stay and secure it in fixture designed for this in the bonnet.



WARNING

Hot coolant can scald!

- Never open the bonnet if you see steam, smoke or coolant escaping from the engine compartment.

 **WARNING (Continued)**

- Wait until no more steam, smoke or coolant is emitted from the bonnet, then carefully open the bonnet.
- When working in the engine compartment, always observe the safety warnings ⇒ page 200.

Closing the bonnet

- Slightly raise the bonnet
- Release the bonnet stay and replace it in its support.
- At a height of about 30 cm let it fall so it is locked.

If the bonnet does not close, do not press downwards. Open it once more and let it fall as before.

 **WARNING**

If the bonnet is not closed properly, it could open while you are driving and completely obscure your view of the road. Risk of accident.

- After closing the bonnet, always check that it is properly secured. The bonnet must be flush with the surrounding body panels.
- If you notice that the bonnet latch is not secured when the vehicle is moving, stop the vehicle immediately and close the bonnet properly. Risk of accident.

Engine oil

General notes

The engine comes with a special, multi-grade oil that can be used all year round.

Because the use of high-quality oil is essential for the correct operation of the engine and its long useful life, when topping up or changing oil, use only those oils that comply with VW standards.

The specifications (VW standards) set out in the following page should appear on the container of the service oil; when the container displays the specific standards for petrol and diesel engines together, it means that the oil can be used for both types of engines.

We recommend that the oil change, indicated in the Maintenance Programme, be performed by a Technical Service or a specialised workshop.

The correct oil specifications for your engine are listed in ⇒ page 204, Oil properties.

Service intervals

Service intervals can be flexible (LongLife service) or fixed (dependent on time/distance travelled).

If the PR code that appears on the back of the “Maintenance Programme” booklet is QG1, this means that your vehicle has the LongLife service programmed. If it has the codes QG0 or QG2 the interval service is dependent on time/distance travelled.

Flexible service intervals (LongLife service intervals*)

Special oils and processes have been developed which, depending on the characteristics and individual driving profiles, enable the extension of the oil change service (LongLife service intervals). ▶

Because this oil is essential for extending the service intervals, it **must only** be used observing the following indications:

- Avoid mixing it with oil for fixed service intervals.
- Only in exceptional circumstances, if the engine oil level is too low ⇒ page 205 and LongLife oil is not available, it is permitted to top up (once) with oil for **fixed service intervals** ⇒ page 204 (up to a maximum of 0.5 litres).

Fixed service intervals*

If your vehicle does not have the “LongLife service interval” or it has been disabled (by request), you may use oils for **fixed service intervals**, which also appear in ⇒ page 204, Oil properties. In this case, your vehicle must be serviced after a fixed interval of 1 year/15 000 km (10 000 miles)(whatever comes first) ⇒ Booklet Maintenance Programme.

- In exceptional circumstances, if the engine oil level is too low ⇒ page 205 and you cannot obtain the oil specified for your vehicle, you can put in a small quantity of oil conforming to the specification ACEA A2 or ACEA A3 (petrol engines) or ACEA B3 or ACEA B4 (diesel engines) (up to 0.5 l).

Vehicles with diesel particulate filter*

The “Maintenance Programme” states whether your vehicle is fitted with a diesel particulate filter.

Only VW 507 00 engine oil, with reduced ash formation, may be used in diesel engines equipped with particulate filter. Using other types of oil will cause a higher soot concentration and reduce the life of the DPF. Therefore:

- Avoid mixing this oil with other engine oils.
- Only in exceptional circumstances, if the engine oil level is too low ⇒ page 205 and you cannot obtain the oil specified for your vehicle, you can use a small quantity of oil (once) conforming to the VW 506 00, VW 506 01, VW 505 00, VW 505 01 or ACEA B3 / ACEA B4 specification. (up to 0.5 l).

Oil properties

Engine type	Specification
Petrol without flexible service interval	VW 502 00/VW 504 00
Petrol with flexible service interval (LongLife)	VW 504 00
Diesel. Engines without Particulate filter (DPF)	VW 505 01/VW 506 01/VW 507 00
Diesel. Particulate Filter Engines (DPF). With or without flexible service interval (with and without LongLife) ^{a)}	VW 507 00

^{a)} Only use recommended oils, otherwise you may damage the engine.

Engine oil additives

No type of additive should be mixed with the engine oil. The deterioration caused by these additives is not covered by the warranty.



Note

Before a long trip, we recommend finding an engine oil that conforms to the corresponding VW specifications and recommend keeping it in the vehicle. This way, the correct engine oil will always be available for a top-up if needed. ■

Checking the engine oil level

The engine oil dipstick indicates the level of the oil.

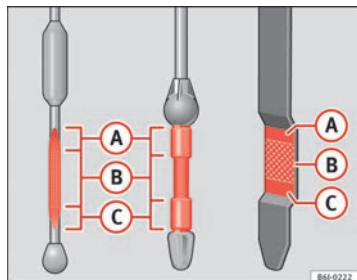

Fig. 133 Engine oil dipstick

Checking oil level

- Park the vehicle in a horizontal position.
- Briefly run the engine at idle speed until the operating temperature is reached and then stop.
- Wait two minutes.
- Pull out the dipstick. Wipe the dipstick with a clean cloth and insert it again, pushing it in as far as it will go.
- Then pull it out once more and check the oil level ⇒ Fig. 133. Top up with engine oil if necessary.

Oil level in area **A**

- Do **not** add oil ⇒ .

Oil level in area **B**

- You **can** add oil, but keep the level in this zone.

Oil level in area **C**

- Oil **must** be added. **Afterwards**, the oil level should be in the lined area **B**.

Depending on how you drive and the conditions in which the vehicle is used, oil consumption can be up to 0.5 l/1000 km. Oil consumption is likely to be higher for the first 5000 km (3000 miles). For this reason the engine oil level must be checked at regular intervals, preferably when filling the tank and before a journey.

WARNING

Any work carried out in the engine compartment or on the engine must be carried out cautiously.

- When working in the engine compartment, always observe the safety warnings ⇒ page 200.

CAUTION

If the oil level is above the area **A** do not start the engine. This could result in damage to the engine and catalytic converter. Contact a Technical Service. ■

Topping up engine oil

Top up gradually with small quantities of engine oil.

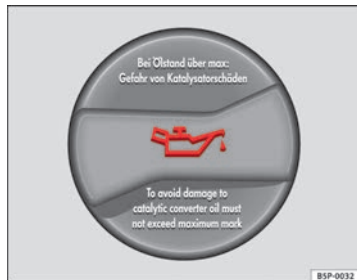



Fig. 134 In the engine compartment: Engine oil filler cap

Before opening the bonnet, read and observe the warnings ⇒  in Safety instructions on working in the engine compartment on page 200.

- Unscrew cap from engine oil filler opening ⇒ **Fig. 134**.
- Top-up oil in small amounts, using the correct oil.
- To avoid over-filling with engine oil, you should top-up using small quantities, wait a while and check the oil level before adding any more oil.
- As soon as the oil level is in area **(B)**, carefully close the cap.

The position of the oil filler opening is shown in the corresponding engine compartment illustration ⇒ page 259.

Engine oil specification ⇒ page 204.



WARNING

Oil is highly flammable! Ensure that no oil comes into contact with hot engine components when topping up.



CAUTION

If the oil level is above the area **(A)** do not start the engine. This could result in damage to the engine and catalytic converter. Contact a specialised workshop.



For the sake of the environment

The oil level must never be above area **(A)**. Otherwise oil can be drawn in through the crankcase breather and escape into the atmosphere via the exhaust system. ■

Changing engine oil

The engine oil must be changed at the intervals given in the service schedule.

We recommend that you have the engine oil changed by a Technical Service.

The oil change intervals are shown in the Maintenance Programme. ►

**WARNING**

Only change the engine oil yourself if you have the specialist knowledge required!

- Before opening the bonnet, read and observe the warnings ⇒ page 200, Safety instructions on working in the engine compartment.
- Wait for the engine to cool down. Hot oil may cause burn injuries.
- Wear eye protection to avoid injuries, such as acid burns, caused by splashes of oil.
- When removing the oil drain plug with your fingers, keep your arm horizontal to help prevent oil from running down your arm.
- Wash your skin thoroughly if it comes into contact with engine oil.
- Engine oil is poisonous! Used oil must be stored in a safe place out of the reach of children.

**CAUTION**

No additives should be used with engine oil. This could result in engine damage. Any damage caused by the use of such additives would not be covered by the factory warranty.

**For the sake of the environment**

- Because of the disposal problems, the necessary special tools and specialist knowledge required, we recommend that you have the engine oil and filter changed by a Technical Service.
- Never pour oil down drains or into the ground.
- Use a suitable container when draining the used oil. It must be large enough to hold all the engine oil.

Coolant

Engine coolant specifications

The engine cooling system is supplied from the factory with a specially treated mixture of water and, at least, 40 % of the additive **G 13** (TL-VW 774 J). The engine coolant additive is recognisable by its purple colour. This mixture of water and additive gives the necessary frost protection down to -25°C (-13°F) and protects the light alloy parts of the cooling system against corrosion. It also prevents scaling and considerably raises the boiling point of the coolant.

To protect the engine cooling system, the percentage of additive must *always* be at least 40 %, even in warm climates where anti-freeze protection is not required.

If greater frost protection is required in very cold climates, the proportion of additive can be increased. However, the percentage of additive should not exceed 60 %, as this would reduce the frost protection and, in turn, decrease the cooling capacity.

When the coolant is topped up, use a mixture of **distilled water** and, at least, 40 % of the G 13 or G 12 plus-plus (TL-VW 774 G) additive (both are purple) to obtain an optimum anticorrosion protection ⇒ ①. The mixture of G 13 with G 12 plus (TL-VW 774 F), G 12 (red) or G 11 (green-blue) engine coolants will significantly reduce the anticorrosion protection and should, therefore be avoided ⇒ ②. ▶

WARNING

If there is not enough anti-freeze in the coolant system, the engine may fail leading to serious damage.

- Please make sure that the percentage of additive is correct with respect to the lowest expected ambient temperature in the zone in which the vehicle is to be used.
- When the outside temperature is very low, the coolant could freeze and the vehicle would be immobilised. In this case, the heating would not work either and inadequately dressed passengers could die of cold.

CAUTION

The original additives should never be mixed with coolants which are not approved by SEAT. Otherwise, you run the risk of causing severe damage to the engine and the engine cooling system.

- If the fluid in the expansion tank is not purple but is, for example, brown, this indicates that the G 13 additive has been mixed with an inadequate coolant. The coolant must be changed as soon as possible if this is the case! This could result in serious faults and engine damage.



For the sake of the environment

Coolants and additives can contaminate the environment. If any fluids are spilled, they should be collected and correctly disposed of, with respect to the environment.

Checking the coolant level and topping up

The correct coolant level is important for fault-free functioning of the engine cooling system.

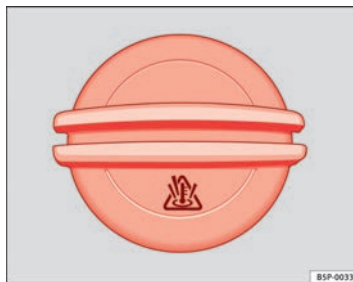



Fig. 135 In the engine compartment: Coolant expansion tank cap

Before opening the bonnet, read and observe the warnings \Rightarrow  in Safety instructions on working in the engine compartment on page 200.

Opening the coolant expansion tank

- Switch off the engine and allow it to cool.
- To prevent scalding, cover the cap on the coolant expansion tank with a thick cloth and carefully unscrew the cap \Rightarrow .

Checking coolant level

- Look into the open coolant expansion tank and read off the coolant level.
- If the level is below the “MIN” mark, top up with coolant. \blacktriangleright

Topping up coolant

- Only use **new** coolant liquid.
- Do not fill above the “MAX” mark.

Closing the coolant expansion tank

- Screw the cap on again *tightly*.

The position of the coolant expansion reservoir is shown in the corresponding engine compartment illustration ⇒ page 259.

Ensure the coolant conforms to the required specifications. Do not use a different type of additive if additive G 12++ is not available. In this case use only water and bring the coolant concentration back up to the correct level as soon as possible by putting in the specified additive.

Always top up with *new* coolant.

Do not fill above the “MAX” mark. Otherwise the excess coolant will be forced out of the cooling system when the engine is hot.

The additive G 12++ can be mixed with the G 12+ in any proportion.



WARNING

Any work carried out in the engine compartment or on the engine must be carried out cautiously.

- When working in the engine compartment, always observe the safety warnings ⇒ page 200.
- When the engine is warm or hot, the cooling system is pressurised! Do not unscrew the cap on the coolant expansion tank when the engine is hot. This is a burn injury risk.



CAUTION

- If you notice a change in the colour of the liquid because it has been in use for a long time, it is recommended to change it, as it will have lost some of its properties and could cause damage to the vehicle.
- If a lot of coolant fluid has been lost, wait for the engine to *cool down* before putting in cold coolant. This avoids damaging the engine. Large coolant losses are an indication of leaks in the cooling system. See a specialised workshop immediately and have the cooling system checked. Otherwise, there is a risk of engine damage.

Washer fluid and windscreen wiper blades

Topping up washer fluid

The water for cleaning the windscreen should always be mixed with washer fluid.



Fig. 136 In the engine compartment: Cap of windscreen washer fluid reservoir.

The **windscreen washer** and the **headlight washers** are supplied with fluid from the windscreen washer fluid container in the engine compartment. The container holds approx. 2 litres; in vehicles with headlight washers* it holds approx. 4.5 litres.

The tank is in the engine compartment.

Plain water is not enough to clean the windscreen and headlights. We recommend that you always add a product to the windscreen washer fluid. Approved windscreen cleaning products exist on the market with high detergent and anti-freeze properties, these may be added all-year-round. Please follow the dilution instructions on the packaging.



WARNING

Any work carried out in the engine compartment or on the engine must be carried out cautiously.

- When working in the engine compartment, always observe the safety warnings ⇒ page 200.



CAUTION

- Never put radiator anti-freeze or other additives into the windscreen washer fluid.
- Always use approved windscreen cleansing products diluted as per instructions. If you use other washer fluids or soap solutions, the tiny holes in the fan-shaped nozzles could become blocked. ■

Changing windscreen wiper blades

If the windscreen wiper blades are in perfect condition, you will benefit from an improved visibility. Damaged wiper blades should be replaced immediately.

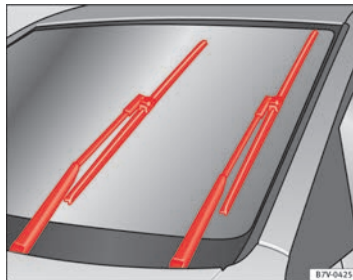

Fig. 137 Windscreen wipers in service position

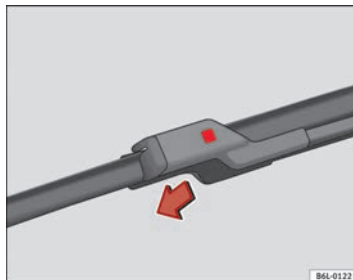

Fig. 138 Change windscreen wiper blade ▶

To change the blades it is necessary to change the rest position of the wipers to the service position.

Do not change the windscreen wipers when out of the service position, as it could cause paint to flake off the bonnet due to friction with the windscreen wiper arm.

Service position (For changing wiper blades)

- Ensure that the wiper blades are not frozen.
- Turn ignition on and off and then (before approx. 9 sec.) move the windscreen wiper lever to the intermittent wipe position. The windscreen wipers will move to the service position ⇒ Fig. 137.

Removing the wiper blade

- Lift the windscreen wiper arm.
- Press on the securing tab ⇒ Fig. 138.
- Extract the wiper blade from the wiper arm.

Fitting the wiper blade

- Insert the wiper blade onto the windscreen wiper arm until it clicks into place.
- Place the windscreen wiper arms to their initial position.

If the **windscreen wipers smear**, they should be replaced if they are damaged, or cleaned if they are soiled.

If this does not produce the desired results, the setting angle of the windscreen wiper arms might be incorrect. They should be checked by a specialised workshop and corrected if necessary.



WARNING

Do not drive unless you have good visibility through all windows!

- Clean the windscreen wiper blades and all windows regularly.
- The wiper blades should be changed once or twice a year.



CAUTION

- Damaged or dirty windscreen wipers could scratch the windscreen.
- Never use fuel, nail varnish remover, paint thinner or similar products to clean the windows. This could damage the windscreen wiper blades.
- Never move the windscreen wiper or windscreen wiper arm manually. This could cause damage.
- To avoid damage to the bonnet and the windscreen wiper arms, the latter should only be lifted off the windscreen when in service position.



Note

- The windscreen wiper arms can be moved to the service position only when the bonnet is properly closed.
- You can also use the service position, for example, if you want to fix a cover over the windscreen in the winter to keep it clear of ice. ■

Changing the rear wiper blade

A good rear wiper blade is essential for clear rear vision. Damaged wiper blades should be replaced immediately.

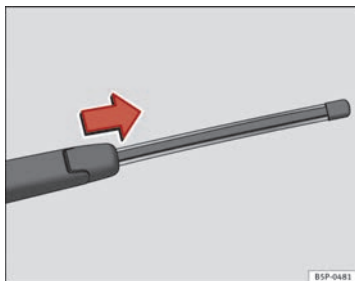

Fig. 139 Removing the rear window wiper blade

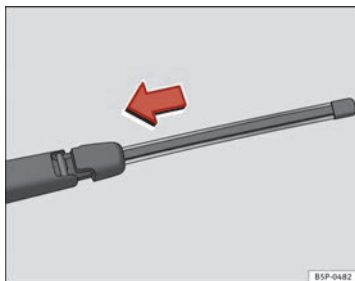

Fig. 140 Fitting the rear window wiper blade

Removing the wiper blade

- Lift the wiper arm away from the glass ⇒ Fig. 139.
- Slide the blade adapter in the direction of the arrow and remove the blade ⇒ Fig. 139.

Fitting the wiper blade

- With one hand, hold the top end of the wiper arm.
- Place the blade as shown in the ⇒ Fig. 140 and slide the adapter along until it engages.

Check the condition of the wiper blade regularly. Change as required.

If the **windscreen wiper scrapes**, it should be replaced if damaged, or cleaned if soiled.

If this is not sufficient, refer to a specialised workshop.



WARNING

Do not drive unless you have good visibility through all windows!

- Clean the windscreen wiper blades and all windows regularly.
- The wiper blades should be changed once or twice a year.



CAUTION

- A damaged or dirty window wiper could scratch the rear window.
- Never use fuel, nail varnish remover, paint thinner or similar products to clean the window.
- Never move the windscreen wiper by hand. This could cause damage. ■

Brake fluid

Checking the brake fluid level

The brake fluid is checked at the intervals given in the service schedule.



Fig. 141 In the engine compartment: Brake fluid reservoir cover

- Read off the fluid level at the transparent brake fluid reservoir. It should always be between the “MIN” and “MAX” marks.

The position of the brake fluid reservoir is shown in the corresponding engine compartment illustration ⇒ page 259. The brake fluid reservoir has a black and yellow cap.

The brake fluid level drops slightly when the vehicle is being used as the brake pads are automatically adjusted as they wear.

However, if the level goes down noticeably in a short time, or drops below the “MIN” mark, there may be a leak in the brake system. A display on the instrument panel will warn you if the brake fluid level is too low ⇒ page 65.

WARNING

Before opening the bonnet to check the brake fluid level, read and observe the warnings ⇒ page 200.

Changing the brake fluid

The Maintenance Programme indicates the brake fluid change intervals.

We recommend that you have the brake fluid changed by a Technical Service.

Before opening the bonnet, please read and follow the warnings ⇒  in Safety instructions on working in the engine compartment on page 200 in section “Safety notes for working in the engine compartment”.

Brake fluid absorbs moisture. In the course of time, it will absorb water from the ambient air. If the water content in the brake fluid is too high, the brake system could corrode. This also considerably reduces the boiling point of the brake fluid. Heavy use of the brakes may then cause a vapour lock which could impair the braking effect.

Be sure to always use the correct brake fluid. Only use brake fluid that expressly meets VW 501 14 standards.

You can buy VW 501 14 standard brake fluid in a SEAT dealership or SEAT Official Service. If none is available, use only high quality brake fluid that meets DIN ISO 4925 CLASS 4 standards, or USA Standards FMVSS 116 DOT 4.

Using any other kind of brake fluid or one that is not of a high quality may affect operation of the brake system and reduce its effectiveness. Never use a brake fluid if the container does not state that it complies with VW 501 14, DIN ISO 4925 CLASS 4 standards, or USA standards FMVSS 116 DOT 4. ▶

 **WARNING**

Brake fluid is poisonous. Old brake fluid impairs the braking effect.

- Before opening the bonnet to check the brake fluid level, read and observe the warnings → page 200.
- Brake fluid should be stored in the closed original container in a safe place out of reach of children. There is a toxic risk.
- Complete the brake fluid change according to the Maintenance Programme. Heavy use of the brakes may cause a vapour lock if the brake fluid is left in the brake system for too long. This would seriously affect the effectiveness of the brakes and the safety of the vehicle. This may cause an accident.

 **CAUTION**

Brake fluid damages the vehicle paintwork. Wipe off any brake fluid from the paintwork immediately.

 **For the sake of the environment**

The brake pads and brake fluid must be collected and disposed of according to the applicable regulations. The SEAT Technical Service network has the necessary equipment and qualified personnel for collecting and disposing of this waste material.

Vehicle battery

Warnings on handling the battery



Wear eye protection



Battery acid is extremely corrosive. Wear protective gloves and eye protection!



Fires, sparks, open flames and smoking are prohibited!



A highly explosive mixture of gases is released when the battery is under charge.



Keep children away from acid and batteries!

 **WARNING**

Always be aware of the danger of injury and chemical burns as well as the risk of accident or fire when working on the battery and the electrical system:

- **Wear eye protection. Protect your eyes, skin and clothing from acid and particles containing lead.**
- **Battery acid is extremely corrosive. Wear protective gloves and eye protection. Do not tilt the batteries. This could spill acid through the vents. Rinse battery acid from eyes immediately for several minutes with clear water. Then seek medical care immediately. Neutralise any acid splashes on the skin or clothing with a soapy solution, and rinse off with plenty of water. If acid is swallowed by mistake, consult a doctor immediately.**

 **WARNING (Continued)**

● Fires, sparks, open flames and smoking are prohibited. When handling cables and electrical equipment, avoid causing sparks and electrostatic charge. Never short the battery terminals. High-energy sparks can cause injury.

● A highly explosive mixture of gases is released when the battery is under charge. The batteries should be charged in a well-ventilated room only.

● Keep children away from acid and batteries.

● Before working on the electrical system, you must switch off the engine, the ignition and all consumers. The negative cable on the battery must be disconnected. When a light bulb is changed, you need only switch off the light.

● Deactivate the anti-theft alarm by unlocking the vehicle before you disconnect the battery! The alarm will otherwise be triggered.

● When disconnecting the battery from the vehicle on-board network, disconnect first the negative cable and then the positive cable.

● Switch off all electrical consumers before reconnecting the battery. Reconnect first the positive cable and then the negative cable. Never reverse the polarity of the connections. This could cause an electrical fire.

● Never charge a frozen battery, or one which has thawed. This could result in explosions and chemical burns. Always replace a battery which has frozen. A flat battery can freeze at temperatures around 0°C.

● Ensure that the vent hose is always connected to the battery.

● Never use a defective battery. This could cause an explosion. Replace a damaged battery immediately.

● For vehicles with the battery in the luggage compartment: Check that the battery gas ventilation hose is securely attached.

 **CAUTION**



● Never disconnect the battery if the ignition is switched on or if the engine is running. This could damage the electrical system or electronic components.

● Do not expose the battery to direct sunlight over a long period of time, as the intense ultraviolet radiation can damage the battery housing.

● If the vehicle is left standing in cold conditions for a long period, protect the battery from freezing. If it freezes it will be damaged. ■

Checking the electrolyte level

The electrolyte level should be checked regularly in high-mileage vehicles, in hot countries and in older batteries.

– Open the engine bonnet and the battery cover ⇒  in Safety instructions on working in the engine compartment on page 201 ⇒  in Warnings on handling the battery on page 214.

– Check the colour display in the "magic eye" on the top of the battery.

– If there are air bubbles in the window, tap the window gently until they disperse.

The position of the battery is shown in the corresponding engine compartment diagram ⇒ page 259.

The "magic eye" indicator, located on the top of the battery changes colour, depending on the charge state and electrolyte level of the battery.

There are two different colours: ▶

- Black: correct charge status.
- Transparent/clear yellow: the battery must be replaced. Contact a specialised workshop.

Charging and changing the vehicle battery

The battery is maintenance-free and is checked during the inspection service. All work on the vehicle battery requires specialist knowledge.

If you often drive short distances or if the vehicle is not driven for long periods, the battery should be checked by a specialised workshop between the scheduled services.

If the battery has discharged and you have problems starting the vehicle, the battery might be damaged. If this happens, we recommend you have the vehicle battery checked by a Technical Service where it will be re-charged or replaced.

Charging the battery

The vehicle battery should be charged by a specialised workshop only, as batteries using special technology have been installed and they must be charged in a controlled environment.

Replacing a vehicle battery

The battery has been developed to suit the conditions of its location and has special safety features.

Genuine SEAT batteries fulfil the maintenance, performance and safety specifications of your vehicle.



WARNING

- We recommend you use only maintenance-free or cycle free leak-proof batteries which comply with standards T 825 06 and VW 7 50 73. This standard applies as of August 2001.
- Before starting any work on the batteries, you must read and observe the warnings ⇒ in Warnings on handling the battery on page 214.



For the sake of the environment

Batteries contain toxic substances such as sulphuric acid and lead. They must be disposed of appropriately and must not be disposed of with ordinary household waste.

Wheels

General notes

Avoiding damage

- If you have to drive over a kerb or similar obstacle, drive very slowly and at a right angle.
- Keep grease, oil and fuel off the tyres.
- Inspect the tyres regularly for damage (cuts, cracks or blisters, etc.). Remove any foreign objects embedded in the treads.

Storing tyres

- When you remove the tyres, mark them in order to maintain the same direction of rotation when they are installed again. ▶

- When removed, the wheels and/or tyres should be stored in a cool, dry and preferably dark location.
- Store tyres in a vertical position if they are not fitted on wheel rims.

New tyres

New tyres must be run in ⇒ page 173.

The tread depth of new tyres may vary, according to the type and make of tyre and the tread pattern.

Concealed damage

Damage to tyres and rims is often not readily visible. If you notice unusual vibrations or the vehicle pulling to one side, this may indicate that one of the tyres is damaged. The tyres should be checked immediately by a Technical Service.

Tyres with directional tread pattern

An arrow on the tyre sidewall indicates the direction of rotation on tyres with directional tread. Always observe the direction of rotation indicated when fitting the wheel. This guarantees optimum grip and helps to avoid aquaplaning, excessive noise and wear.

WARNING

- New tyres do not have maximum grip during the first 500 km (300 miles). Drive particularly carefully to avoid possible accidents.
- Never drive with damaged tyres. This may cause an accident.
- If you notice unusual vibrations or if the vehicle pulls to one side when driving, stop the vehicle immediately and check the tyres for damage.

Checking tyre pressure

The correct tyre pressure can be seen on the sticker on the inside of the fuel tank flap.

1. Read the required tyre inflation pressure from the sticker. The values refer to Summer tyres.
2. The tyre pressures should only be checked when the tyres are cold. The slightly raised pressures of warm tyres must not be reduced.
3. Adjust the tyre pressure to the load you are carrying.

Tyre pressure

The correct tyre pressure is especially important at high speeds. The pressure should therefore be checked at least once a month and before starting a journey.

WARNING

A tyre can easily burst if the pressure is too low, causing an accident!

- At continuously high speeds, a tyre with insufficient pressure flexes more. In this way it becomes too hot, and this can cause tread separation and tyre blow-out. Always observe the recommended tyre pressures.
- If the tyre pressure is too low or too high, the tyres will wear prematurely and the vehicle will not handle well. Risk of accident!



For the sake of the environment

Under-inflated tyres will increase fuel consumption.

Tyre useful life

The useful life of tyres is dependent on tyre pressure, driving style and fitting.



Fig. 142 Tyre tread wear indicators

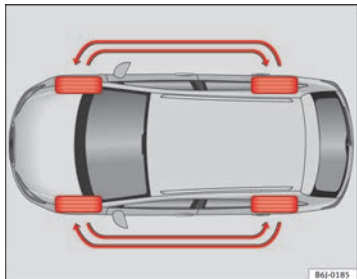

Fig. 143 Diagram for changing wheels

Wear indicators

The original tyres on your vehicle have 1.6 mm high “tread wear indicators” ⇒ Fig. 142, running across the tread. Depending on the make, there will be 6 to 8 of them evenly spaced around the tyre. Markings on the tyre sidewall (for instance the letters “TWI” or other symbols) indicate the positions of the tread wear indicators. The minimum tread depth required by law is 1.6 mm (measured in the tread grooves next to the tread wear indicators). Worn tyres must be replaced. Different figures may apply in export countries ⇒ ⚠.

Tyre pressure

Incorrect tyre pressure causes premature wear and could cause tyre blow-out. For this reason, the tyre pressure should be checked at least once per month ⇒ page 217.

Driving style

Fast cornering, heavy acceleration and hard braking all increase tyre wear.

Changing wheels around

If the front tyres are worn considerably more than the rear ones it is advisable to change them around as shown ⇒ Fig. 143. The useful life of all the tyres will then be about the same time.

Wheel balance

The wheels on new vehicles are balanced. However, various factors encountered in normal driving can cause them to become unbalanced, which results in steering vibration.

Unbalanced wheels should be rebalanced, as they otherwise cause excessive wear on steering, suspension and tyres. A wheel must also be rebalanced when a new tyre is fitted.

Incorrect wheel alignment

Incorrect wheel alignment causes excessive tyre wear, impairing the safety of the vehicle. If tyres show excessive wear, you should have the wheel alignment checked by a Technical Service. ▶

**WARNING**

There is a serious danger of accidents if a tyre bursts during driving!

- The tyres must be replaced at the latest when the tread wear indicators are worn → page 218. Failure to do so could result in an accident. Worn tyres do not grip well at high speeds on wet roads. There is also a greater risk of aquaplaning.
- At continuously high speeds, a tyre with insufficient pressure flexes more. This causes it to overheat. This can cause tread separation and tyre blow-out. Risk of accident. Always observe the recommended tyre pressures.
- If tyres show excessive wear, you should have the running gear checked by a Technical Service.
- Keep chemicals such as oil, fuel and brake fluid away from tyres.
- Damaged wheels and tyres must be replaced immediately!

**For the sake of the environment**

Under-inflated tyres will increase fuel consumption.

New tyres and wheels

New tyres and wheels have to be run in.

The tyres and wheel rims are an essential part of the vehicle's design. The tyres and rims approved by SEAT are specially matched to the characteristics of the vehicle and make a major contribution to good road holding and safe handling ⇒ .

Tyres should be replaced at least in pairs and not individually (i.e. both front tyres or both rear tyres together). A knowledge of tyre designations makes it easier to choose the correct tyres. Radial tyres have the tyre designations marked on the sidewall, for example:

195/65 R15 91T

This contains the following information:

- 195 Tyre width in mm
- 65 Height/width ratio in %
- R Tyre construction: Radial
- 15 Rim diameter in inches
- 91 Load rating code
- T Speed rating

The tyres could also have the following information:

- A direction of rotation symbol
- "Reinforced" denotes heavy-duty tyres.

The manufacturing date is also indicated on the tyre sidewall (possibly only on the inner side of the wheel).

“DOT... 1103...” means, for example, that the tyre was produced in the 11th week of 2003.

We recommend that work on tyres and wheels be carried out by a Technical Service. They are familiar with the procedure and have the necessary special tools and spare parts as well as the proper facilities for disposing of the old tyres.

Any Technical Service has full information on the technical requirements when installing or changing tyres, wheels or wheel trims. ▶

**WARNING**

- We recommend that you use only wheels and tyres which have been approved by SEAT for your model. Failure to do so could impair vehicle handling. Risk of accident.
- Avoid running the vehicle on tyres that are more than 6 years old. If you have no alternative, you should drive slowly and with extra care at all times.
- Never use old tyres or those with an unknown history of use.
- If wheel trims are retrofitted, you must ensure that the flow of air to the brakes is not restricted. This could cause the brake system to overheat.
- All four wheels must be fitted with radial tyres of the same type, size (rolling circumference) and the same tread pattern.

**For the sake of the environment**

Old tyres must be disposed of according to the laws in the country concerned.

**Note**

- For technical reasons, it is not generally possible to use the wheels from other vehicles. This can also apply to wheels of the same model. The use of wheels or tyres which have not been approved by SEAT for use with your model may invalidate the vehicle's type approval for use on public roads.
- If the spare wheel is not the same as the tyres that are mounted on the vehicle (e.g. winter tyres) you should only use the spare tyre for a short period of time and drive with extra care. Refit the normal road wheel as soon as possible.

Wheel bolts

Wheel bolts must be tightened to the correct torque.

The design of wheel bolts is matched to the rims. If different wheel rims are fitted, the correct wheel bolts with the right length and correctly shaped bolt heads must be used. This ensures that wheels are fitted securely and that the brake system functions correctly.

In certain circumstances, you should not use wheel bolts from a different vehicle, even if it is the same model ⇒ page 190.

**WARNING**

If the wheel bolts are not tightened correctly, the wheel could become loose while driving. Risk of accident.

- The wheel bolts must be clean and turn easily. Never apply grease or oil to them.
- Use only wheel bolts which belong to the wheel.
- If the prescribed torque of the wheel bolts is too low, they could loosen whilst the vehicle is in motion. Risk of accident! If the tightening torque is too high, the wheel bolts and threads can be damaged.

**CAUTION**

The prescribed tightening torque for wheel bolts for steel and alloy wheels is 120 Nm.

Winter tyres

Winter tyres will improve the vehicles handling on snow and ice.

In winter conditions winter tyres will considerably improve the vehicle's handling. The design of summer tyres (width, rubber compound, tread pattern) gives less grip on ice and snow.

Winter tyres must be inflated to a **pressure** 0.2 bar higher than the pressures specified for summer tyres (see sticker on fuel tank flap).

Winter tyres must be fitted on all four wheels.

Information on permitted **winter tyre sizes** can be found in the vehicle's registration documentation. Use only radial winter tyres. All tyre sizes listed in the vehicle documentation also apply to winter tyres.

Winter tyres lose their effectiveness when the tread is worn down to a depth of 4 mm.

The speed rating code → page 219, New tyres and wheels determines the following **speed limits** for winter tyres: ⇒ ⚠

Q	max. 160 km/h (100 mph)
S	max. 180 km/h (110 mph)
T	max. 190 km/h (120 mph)
H	max. 210 km/h (130 mph)

In some countries, vehicles which can exceed the speed rating of the fitted tyre must have an appropriate sticker in the driver's field of view. These stickers are available from your Technical Service. The legal requirements of each country must be followed.

Do not have winter tyres fitted for unnecessarily long periods. Vehicles with summer tyres handle better when the roads are free of snow and ice.

If you have a flat tyre, please refer to the notes on the spare wheel
→ page 219, New tyres and wheels.

WARNING

The maximum speed for the winter tyres must not be exceeded. Otherwise, this could lead to tyre damage and risk of accident.



For the sake of the environment

Fit your summer tyres again as soon as possible. They are quieter, do not wear so quickly and reduce fuel consumption.

Snow chains

Snow chains may be fitted only to the front wheels, and only for the following tyres:

175/70R14 185/60R15	Chains with links not exceeding 15 mm (including the chain closure)
215/45R16	Chains with links not exceeding 9 mm (including the chain closure)
215/40R17	Chains with links not exceeding 7 mm (including the chain closure)

Remove wheel hub covers and trim rings before fitting snow chains. For safety reasons cover caps, available in any Technical Service, must then be fitted over the wheel bolts.

WARNING

Snow chains should be correctly tightened in accordance with the manufacturer's instructions. This will prevent the chains coming into contact with the wheel housing.

**CAUTION**

Remove the snow chains to drive on roads without snow. Otherwise they will impair handling, damage the tyres and wear out very quickly.

**Note**

In some countries, the speed limit for using snow chains is 50 km/h (30 mph). The legal requirements of the country should be followed. ■

If and when

Vehicle tools, spare wheel

Vehicle Tools

The vehicle tools are located under the floor panel in the luggage compartment.

- Lift luggage compartment floor panel.
- Take the vehicle tools out of the vehicle.

The vehicle tool kit includes:

- Jack*
- Hook to remove integral* trim and screw caps.
- Box spanner for wheel bolts*
- Towline anchorage*
- Adapter for the anti-theft wheel bolts*

Some of the items listed are only provided in certain model versions, or are optional extras.

WARNING

- **The factory-supplied jack is only designed for changing wheels on this model. On no account attempt to use it for lifting heavier vehicles or other loads. Risk of injury.**
- **Use the jack only on a firm, level ground.**

WARNING (Continued)

- **Never start the engine when the vehicle is on the jack. Risk of accident.**
- **If work is to be carried out underneath the vehicle, this must be secured by suitable means. Otherwise, there is a risk of injury.**

Spare wheel (temporary spare wheel)*

The spare wheel (temporary spare wheel) must only be used for the minimum necessary time.

The temporary spare wheel is stored under the floor panel in the luggage compartment and is attached by a thumbnut.

How to use the temporary spare wheel

If you ever have a punctured tyre or loss of pressure, the temporary spare wheel is only intended for temporary use until you reach a workshop. Change it for a duty wheel as soon as possible.

Please note the following restrictions when using the temporary spare wheel. This temporary spare wheel has been specially designed for your vehicle, thus, it cannot be changed with the temporary spare wheel from another vehicle.

No other type of tyre (normal summer or winter tyre) may be fitted on the compact temporary spare wheel rim.

Snow chains

For technical reasons, snow chains must **not** be used on the compact temporary spare wheel. ▶

If you have a puncture on one of the *front wheels* when using snow chains, fit the compact temporary spare wheel in place of one of the rear wheels. You can then attach the snow chains to the wheel taken from the rear and use this wheel to replace the punctured front wheel.



WARNING

- The tyre pressures must be checked and corrected as soon as possible after fitting the temporary spare wheel.
- Do not drive faster than 80 km/h (50 mph). Higher speeds can cause an accident.
- Avoid heavy acceleration, hard braking and fast cornering. Risk of accident.
- Never use more than one temporary spare wheel at the same time, risk of accident.
- No other type of tyre (normal summer or winter tyre) may be fitted on the compact temporary spare wheel rim.

Tyre repair kit*

The tyre repair kit (for vehicles not including a temporary spare wheel) is stored under the floor panel in the luggage compartment.

Your vehicle is equipped with the Tyre Mobility System “Tyre repair kit”.

The tyre repair kit consists of a container with sealing product to repair the puncture and a **compressor** to generate the required tyre pressure. The kit will reliably seal punctures up to a size of about 4 mm caused by the penetration of a foreign body into the tyre.



Note

- Seek professional assistance if the repair of a tyre puncture is not possible with the sealing product.

Wheel change

Preparation work

What you must do before changing a wheel.

- If you have a flat tyre or puncture, park the vehicle as far away from the flow of traffic as possible. Choose a location that is as level as possible.
- All vehicle occupants should leave the vehicle. They should wait in a safe area (for instance behind the roadside crash barrier).
- Switch the engine off. Switch the hazard warning lights on and place the warning triangles in position.
- Apply the **handbrake** firmly.
- Engage the **first gear**, or put the selector lever to position **P** for those vehicles with an automatic gearbox.
- If you are towing a trailer, unhitch it from your vehicle.
- Take the **vehicle tools** and the **spare wheel** out of the luggage compartment.

**WARNING**

Switch on the hazard warning lights and place the warning triangles in position. This is for your own safety and also warns other road users.

**CAUTION**

If you have to change the wheel on a slope, it is essential to lock the parallel wheel on the same axle as that to be changed, with a wedge or similar in order to immobilise the vehicle.

**Note**

Please observe legal requirements when doing so.

Changing a wheel

Change the wheel as described below

- Remove the **hub caps or the integral trim**.
- Slacken the **wheel bolts**.
- **Raise** the vehicle with the jack at the corresponding point.
- **Remove** the wheel and then **fit** the spare wheel.
- **Lower** the vehicle.
- Tighten the wheel bolts **firmly** with the box spanner.
- Replace the **hub cap**.

After changing a wheel

After changing the wheel there are still tasks to complete.

- Put the tools and jack back in the luggage compartment.
- Place the wheel with the defective tyre in the luggage compartment and secure it.
- Check the tyre pressure of the newly fitted tyre as soon as possible.
- Have the tightening torque of the wheel bolts checked as soon as possible with a torque wrench. The prescribed torque must be 120 Nm.

**Note**

- If you notice that the wheel bolts are corroded and difficult to turn when changing a wheel, they must be replaced before having the wheel bolt tightening torque checked.
- For safety reasons, drive at moderate speeds until the wheel bolt tightening torque has been checked.

Wheel covers*

The wheel covers must be removed for access to the wheel bolts

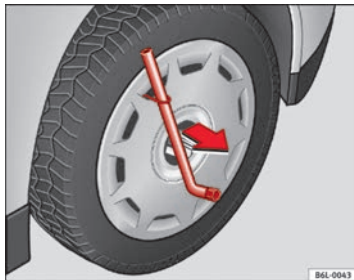

Fig. 144 Remove the complete hub cap

Removing

- Remove the wheel cover using the wire hook ⇒ Fig. 144.
- Hook this into one of the cut-outs of the wheel cover.

Fitting

- Fit the wheel cover onto the wheel rim by pressing it firmly. Put pressure initially on the point of the cut-out for the valve. Next fit the rest of the hub cap

Loosening the wheel bolts

The wheel bolts must be loosened before raising the vehicle.

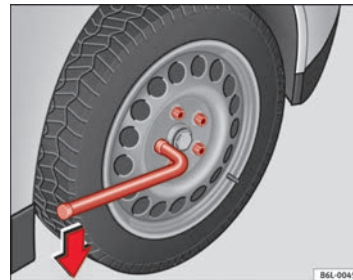

Fig. 145 Changing a wheel: loosen the wheel bolts

Loosening

- Fit the **box spanner** as far as it will go over the wheel bolt.
- Grasp the box spanner by the end turn it about one full turn to the **left** ⇒ Fig. 145.

Tightening

- Fit the box spanner as far as it will go over the wheel bolt.
- Grasp the box spanner close to the end and turn the bolt to the right until it is secured.
- An adapter is required to unscrew or tighten the anti-theft wheel bolts. ▶

WARNING

Loosen the wheel bolts only about one turn before raising the vehicle with the jack, otherwise there is a risk of accident.

Note

- If the wheel bolt is very tight, you may be able to loosen it by pushing down the end of the spanner carefully with your foot. Hold on to the vehicle for support and take care not to slip.

Raising the vehicle

In order to remove the wheel, the vehicle must be raised with a jack.

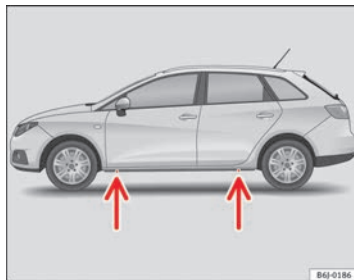

Fig. 146 Jack position points

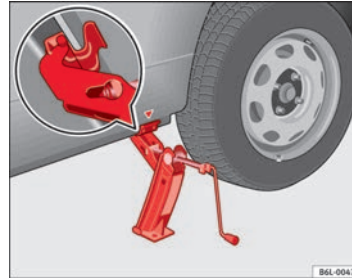

Fig. 147 Fitting the jack

- Locate the jacking point under the door sill closest to the wheel to be changed ⇒ Fig. 146.
- Place the jack under the jacking point and turn the crank until the arm of the jack is directly below the vertical rib under the door sill.
- Align the jack so that the arm of the jack fits around the rib under the door sill and the movable base plate of the jack is flat on the ground ⇒ Fig. 147.
- Raise the jack until the defective wheel is just clear of the ground.

Recesses at the front and rear of the door sills mark the jacking points ⇒ Fig. 146. There is only one jacking point for each wheel. Do not fit the jack anywhere else.

An **unstable surface** under the jack may cause the vehicle to slip off the jack. Therefore, the jack must be fitted on solid ground offering good support. Use a large and stable base, if necessary. On a hard, slippery surface (such as tiles) use a rubber mat or similar to prevent the jack from slipping. ►

**WARNING**

- Take all precautions so that the base of the jack does not slip. Failure to do so could result in an accident.
- The vehicle can be damaged if the jack is not applied at the correct jacking points. There is also a risk of injury since the jack can slip off suddenly if it is not properly engaged.

Removing and fitting the wheel

For removal and fitting the wheel, the following tasks must be completed.

After loosening the wheel bolts and raising the vehicle with the jack, change the wheel as described below:

Removing a wheel

- Unscrew the wheel bolts using the box spanner and place them on a clean surface.

Fitting a wheel

- Screw on the wheel bolts and tighten slightly with the box spanner.

The wheel bolts should be clean and easily screwed. Before fitting the spare wheel, inspect the wheel condition and hub mounting surfaces. These surfaces must be clean before fitting the wheel.

If tyres with a specific direction of rotation are fitted, note the direction of rotation.

Anti-theft wheel bolts*

A special adapter is required to turn the anti-theft wheel bolts. This is found in the tool box.

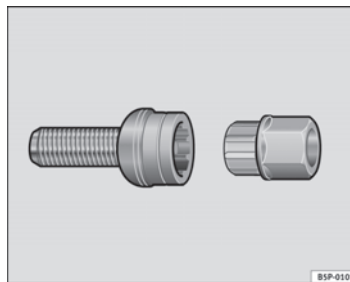

Fig. 148 Anti-theft wheel bolt

- Insert the adapter onto the wheel bolt and push it on as far as it will go ⇒ Fig. 148.
- Fit the box spanner as far as it will go over the adapter.
- Loosen or tighten the wheel bolt as appropriate.

Code

The code number of the anti-theft wheel bolt is stamped onto the front part of the adapter.

The code number should be noted and kept in a safe place, as it is only by using the code number that a duplicate adaptor can be obtained from the SEAT Official Services.

Tyres with directional tread pattern

Tyres with directional tread pattern must be fitted so that they rotate in the correct direction.

A directional tread pattern can be identified by arrows on the sidewall that point in the direction of rotation. Always note the direction of rotation indicated when fitting the wheel. This is important so that these tyres can give maximum grip and avoid excessive noise, tread wear and aquaplaning.

If, in an emergency, you have to fit the spare wheel so it rotates in the wrong direction, you must drive extremely carefully. The tyre will not give optimum performance. This is particularly important when driving on wet roads.

To benefit from the advantages of tyres with this type of tread pattern, the defective tyre should be replaced as soon as possible so that all tyres again rotate in the correct direction. ■

Tyre repair kit (Tyre-Mobility-System)*

General information and safety notes

Your vehicle is equipped with a tyre repair kit: the **Tyre Mobility System**.

In the event of a tyre puncture, a **sealing product** and an **air compressor** are located in the luggage compartment under the floor panel.

The Tyre Mobility System will reliably seal punctures caused by the penetration of a foreign body of up to about 4 mm in diameter.

It is not necessary to remove the foreign body from the tyre.

Instructions for the sealing product are located on the sealing product container.

It also contains the instructions for using the compressor.



WARNING

- Do not attempt to repair a puncture with the sealing product if the tyre has been damaged by driving the vehicle after the tyre has lost its air.
- Always observe warnings and follow safety instructions concerning compressor and sealing compound carefully.
- Do not drive faster than 80 km/h (50 mph), avoid heavy acceleration, hard braking and fast cornering.
- Tyres which have been repaired with sealing compound are only suitable for temporary use over a short period. Therefore, please drive carefully to the next available specialised workshop.



For the sake of the environment

If you have to dispose of a sealant can, go to a specialised waste service or to a SEAT Technical Service, where the product can be recycled in an appropriate waste container.



Note

- If sealing product should leak out, leave it to dry. This way you can pull it off like a piece of foil.
- Observe the expiry date stated on the sealing compound can. Have the sealing compound exchanged by a specialised workshop.
- Seek professional assistance if the repair of a tyre puncture is not possible with the sealing product. ■

What to do first

Certain steps must be taken before repairing a tyre.

- If you have a flat tyre or puncture, park the vehicle as far away from the flow of traffic as possible.
- Apply the **handbrake** firmly.
- Engage **first gear**, or put the selector lever to position **P**.
- All occupants should **leave** the vehicle. They should wait in a safe area (for instance behind the roadside crash barrier).
- Check whether a repair is possible using the Tyre Mobility System “General information and safety notes.”
- Unscrew inflation cap from the affected wheel.
- Take the **tyre repair kit** out of the luggage compartment.



WARNING

Switch on the hazard warning lights and place the warning triangles in position. This is for your own safety and also warns other road users.



CAUTION

Take special care if you have to repair a tyre on a slope.



Note

- Please observe legal requirements when doing so.
- Remember to replace the sealing product as soon as possible. ■

Tyre repair

The following sections describe the procedures for repairing a tyre.

Using the sealing product

- The instructions on the container give detailed information on how to use the sealing product.

Inflating the tyre.

- Remove the air compressor and hose from the container.
- Screw the retaining nut onto the valve.
- Plug the compressor cable into a 12 volt power socket.
- Turn on compressor and monitor the pressure shown on the pressure gauge.

Completing the repair

- Remove the compressor hose from the valve.
- Fit the valve cap.
- Unplug the compressor from the socket.
- Return all tools to their proper storing location.



Note

The compressor should never be allowed to run for longer than 6 minutes. ■

Fuses

Changing a fuse

Blown fuses must be replaced



Fig. 149 Fuses in the dash panel

Fuse cover

- Switch off the ignition and its failed electrical component.
- Identify the fuse corresponding to the damaged electric consumer ⇒ page 232.
- Take the plastic clip from inside the fuse cover, fit it onto the blown fuse and pull the fuse out.
- Replace the blown fuse (which will have a melted metal strip) with a new fuse of the same ampere rating.

The individual electrical circuits are protected by fuses. The fuses are located behind a cover at the left-hand end of the dash panel. When the steer-

ing wheel is on the right, the fuses are on the right-hand side of the dash panel, behind a cover.

Fuses colour code

Colour	Amps
Grey	2
Beige	5
Brown	7,5
Red	10
Blue	15
Yellow	20
Natural (White)	25
Green	30
Orange	40



WARNING

Never “repair” damaged fuses and never replace them with fuses with a higher rating. Failure to comply could result in fire. This could also cause damage to other parts of the electrical system.



Note

- If a newly replaced fuse blows again after a short time, the electrical system must be checked by a specialised workshop as soon as possible.
- If you replace a fuse with higher-rating fuse, you could cause damage to another location in the electrical system.
- Always keep some spare fuses in the vehicle. These are available from SEAT Official Services.

Fuses on left side of dash panel

Fuses

Number	Consumer	Amps
1	Power steering/Engine operation/Flow meter	7,5
2	Diagnostics/Heater/Autoclimate/Climatronic/ Electric anti-dazzle mirror/Navigator/Air conditioning pressure switch/ Climate fan/AFS Control unit/Coming home relay/Soundaktor/CCS	10
3	Petrol engine control unit/Diesel engine control unit/Relay coils/Engine operation/Bi-turbo fuel control unit	5
4	ABS-ESC Control unit/RKA Switch/Gateway control unit/ESC Relay/Rotation sensor	10
5	Reverse light/Heating nozzles	10
6	Instrument panel	5
7	Retro fog light/Start-Stop relays	7,5
8	Paddle levers on steering wheel for automatic gearbox	2
9	Headlight lever/Windscreen wiper switch	10
10	BCM Electronic control unit power supply	5
11	Airbag control unit	5
12	Automatic gearbox/ LPG system	10
13	Exterior mirror control	5
14	Left-hand AFS headlights	15
15	Right-hand AFS headlights	15
16	Vacant	
17	Number plate light	5
18	Clean pump	7,5
19	Electronic control unit	5
20	Turn signals/Brake lights	15

Number	Consumer	Amps
21	Lights control, instrument panel	5
22	Heated mirrors	5
23	Engine injection module/Rain sensor/Automatic gearbox lever/Main petrol relay	7,5
24	Luggage compartment light, interior light, glove compartment light, side lights	10
25	Parking aid	5
26	Towing hook	
27	Headlight control	5
28	Lambda probe	10
29	Vacuum pump/LPG power supply/High-pressure pump	15, 20, 20 ^{a)}
30	Engine solenoid coils/Additional heating relay/ Pressure sensor/AKF Valve	10A
31	Petrol engine operation/Glow plugs/Relay coil/ Electric fan/Secondary water pump relay/Flowmeter	10
32	Engine control unit	15, 20, 30 ^{b)}
33	Clutch switch sensor/Additional heating relay coil/ Servo sensor	5
34	Fuel control unit / Vacuum pump	15
35	Vacant	
36	Main beam with/without AFS	10, 15 ^{c)}
37	Kombi/Coming Home relay/Main beam headlights relay	10
38	Engine heater	30
39	Vacant	
40	12 Volt Input/Cigarette lighter	15
41	Heated seats control unit / Cup Holder	25

Number	Consumer	Amps
42	Horn	20
43	Panoramic roof	30
44	Windscreen wipers	20
45	Heated rear window	30
46	Radio/Bluetooth/USB + AUX-In/DC-DC converter for Start-Stop	20
47	Climatronic/autoclima/Diagnosis/Automatic gearbox (ZSS lock)	5
48	Locking unit	25
49	Front left window raiser	25
50	Rear electric windows	30
51	Right front window raiser	25
52	Alarm	15
53	Electro-kinetic pump relay/bi-turbo fuel control unit	15
54	Reverse light ^{d)} / Fog light/ Cornering light	15
55	Transformer on	15, 20 ^{b)}
56	Rear window wiper	10
57	Left daytime running light/ Turn signals/ Right dipped beam/ Number plate light ^{c)}	15
58	Right daytime running light/ Rear fog light/ Left dipped beam/ Main beam relay/ X Relay ^{c)}	15

a) If it is LPG.

b) Ampere rating according to motorisation.

c) If Start-Stop is installed, lights and/or AFS are automatically switched on.

d) Only with automatic transmission and/or Start-Stop, automatic light-on and/or AFS. ■

Fuses below steering wheel in relay holder

PTC fuses

Number	Consumer	Amps
1	Supplementary electrical heating using air	40
2	Supplementary electrical heating using air	40
3	Supplementary electrical heating using air	40

AUX 1 Fuses

Number	Consumer	Amps
1	Navigator, Bluetooth, MDI, radio control lever	20
2	Instrument panel/ESC Relay	5

AUX 2 Fuses

Number	Consumer	Amps
1	Headlight washer pump	20

AUX 3 Fuses

Number	Consumer	Amps
1	Trailer control unit	15
2	Trailer control unit	20
3	Trailer control unit	20

Fuses in engine compartment above battery

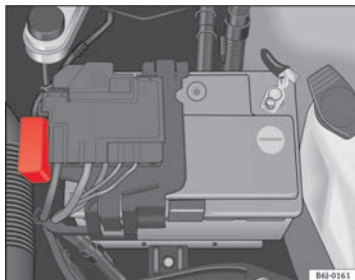

Fig. 150 Fuses in engine compartment

Non-metal fuses

Number	Consumer	Amps
S1	ABS ESC control unit	25
S2	Electroblower climate heater/fan	30
S3	Automatic gearbox control unit	30
S4	Vacant	
S5	Electronic control unit	5
S6	Injection module	30

Some of the electrical items listed in the table are only fitted on certain models or are optional extras.

Please note that the above list contains all data at the time of going to press, so it is subject to modifications.

Bulb change

General notes

Before changing any bulb, first turn off the failed component.

Do not touch the glass part of the bulb with your bare hands. The fingerprints left on the glass will vaporise as a result of the heat generated by the bulb, causing a reduction in bulb life and condensation on the mirror surface, thus reducing effectiveness.

A bulb must only be replaced by one of the same type. The type is indicated on the bulb, either on the glass part or on the base.

Below, the light source used for all functions is broken down.

Double headlights

Dipped beam - H7 Long Life

Main beam - H7

Side - W5W Long Life

Turn signal - PY 21W

Single headlight

Dipped/Main - H4 Long Life

Side - W5W Long Life

Turn signal - PY 21W

Xenon¹⁾ //adaptive headlights*Dipped and full beam - D15²⁾Side - LED³⁾DRL (day light) - LED³⁾

Turn signals - PY 21W

Fog light

Fog light/cornering - H11

! WARNING

- Take particular care when working on components in the engine compartment if the engine is warm. Risk of burns.
- Bulbs are highly sensitive to pressure. The glass can break when you touch the bulb, causing injury.
- The high voltage element of gas discharge bulbs* (xenon light) must be handled correctly. Otherwise, there is a risk of death.
- When changing bulbs, please take care not to injure yourself on sharp parts in the headlight housing.

**CAUTION**

- Remove the ignition key before working on the electric system. Otherwise, a short circuit could occur.
- Switch off the lights or parking lights before you change a bulb.

¹⁾ With this type of headlight, the user can replace the turn signal bulb. Replacement of the dipped/main beam bulb must be done by a Technical Service, given that complex elements must be removed from the vehicle and the automatic control system that incorporates it must be reset.

²⁾ The Xenon bulbs discharge 2.5 times the light flux and have an average lifespan of 5 times more than that of halogen bulbs, this means that, except due to unusual circumstances, there is no need to change the bulbs for the whole life of the vehicle.

³⁾ In the event that there is a fault in the LEDs, the complete headlight must be replaced.

**For the sake of the environment**

Please ask your specialist retailer how to dispose of used bulbs in the proper manner.

**Note**

- Depending on weather conditions (cold or wet), the front lights, the fog lights, the tail lights and the turn signals may be temporarily misted. This has no influence on the useful life of the lighting system. By switching on the lights, the area through which the beam of light is projected will quickly be demisted. However, the edges may continue to be misted.
- Please check at regular intervals that all lighting (especially the exterior lighting) on your vehicle is functioning properly. This is not only in the interest of your own safety, but also that of all other road users.
- Before changing a bulb, make sure you have the correct new bulb.
- Do not touch the glass part of the bulb with your bare hands, use a cloth or paper towel instead. Otherwise, the fingerprints left on the glass will vaporise as a result of the heat generated by the bulb, they will be deposited on the reflector and will impair its surface.

Single headlight bulb change

Single headlight bulb

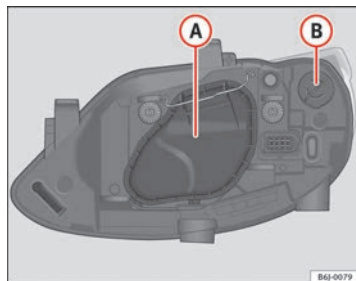

Fig. 151 Single headlight

- Ⓐ Side lights - Dipped beam/main beam.
- Ⓑ Turn signal.

Turn signal bulb

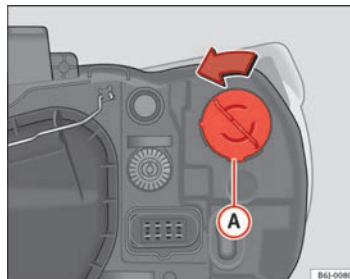

Fig. 152 Single turn signal lamp

- Raise the bonnet.
- Turn bulb holder ⇒ Fig. 152 Ⓐ to the left and pull.
- - Remove the bulb by pressing on the bulb holder and rotating at the same time to the left.
- Installation involves the above steps in reverse sequence. ■

Dipped/main beam headlights

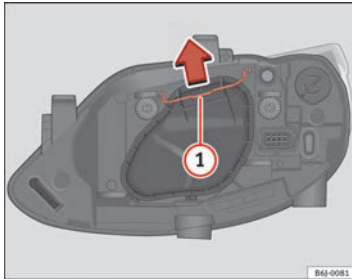

Fig. 153 Dipped beam/
main beam, single head-
light

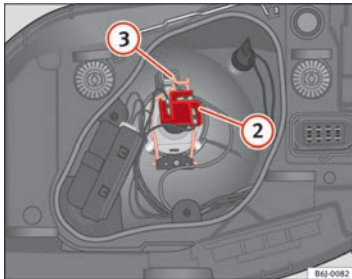

Fig. 154 Dipped beam/
main beam, single head-
light

- Raise the bonnet.
- Move the loop ⇒ Fig. 153 ① in the direction of the arrow and remove the cover.

- Remove connector ⇒ Fig. 154 ② from the bulb.
- Unclip the retainer spring ⇒ Fig. 154 ③ pressing inwards to the right.
- Extract the bulb and fit the replacement so that the rim of the attachment plate is on the reflector cut-out.
- Fit the connector.
- Fit the cover and close the strap. Make sure that the gasket sits well on the casing cover during the operation.
- Check whether the new bulb is working. ■

Side light

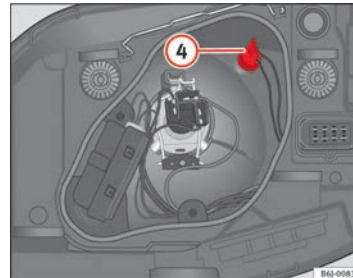

Fig. 155 Side lights

- Raise the bonnet. ▶

- Move the loop ⇒ Fig. 153 ① in the direction of the arrow and remove the cover.
- Remove the bulb holder ④ ⇒ Fig. 155 outwards.
- Replace the bulb by pulling it out and inserting the replacement.
- Installation is done in the reverse order.

Double headlight bulb change

Double headlight

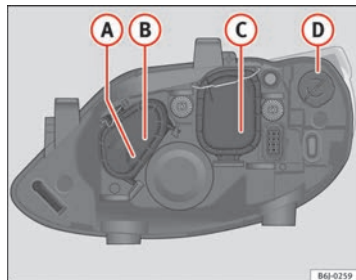

- Ⓐ Side lights
- Ⓑ Main beam headlights

Fig. 156 Double head-lights

- Ⓒ Dipped beam headlights
- Ⓓ Turn signal lights

Side light

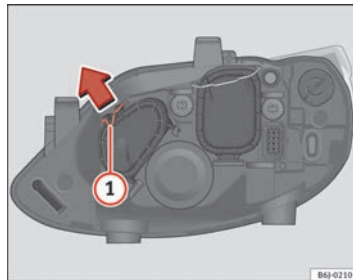

Fig. 157 Side lights

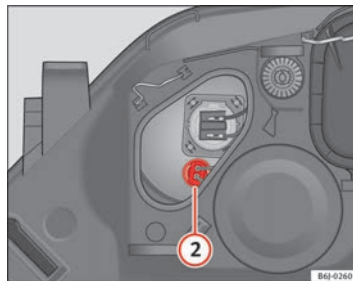

Fig. 158 Side lights

- Raise the bonnet.
- Move the loop ① in the direction of the arrow and remove the cover ⇒ Fig. 157.
- Remove connector ⇒ Fig. 158 ② by pulling outward.
- Remove the bulb by pulling it out and fitting the new one.
- Installation involves the above steps in reverse sequence.
- Fit the cover and close the strap. Make sure that the gasket sits well on the casing cover during the operation.
- Check whether the new bulb is working.

Main beam headlights

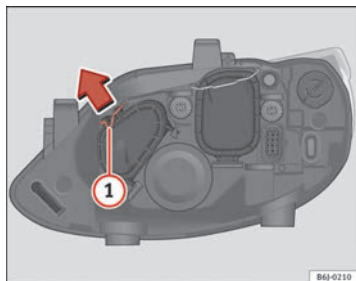

Fig. 159 Main beam headlights

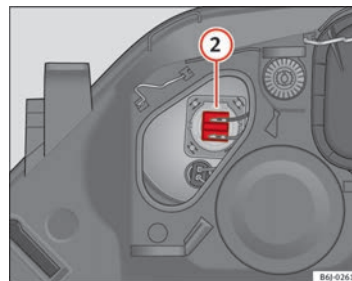

Fig. 160 Main beam headlights

- Raise the bonnet.
- Move the loop ① in the direction of the arrow and remove the cover ⇒ Fig. 159.
- Remove connector ⇒ Fig. 160 ② by pulling outward.
- Extract the bulb and fit the replacement so that it sits correctly into the cut-out on the reflector.
- Installation involves the above steps in reverse sequence.
- Fit the cover and close the strap. Make sure that the gasket sits well on the casing cover during the operation.
- Check whether the new bulb is working.

Dipped beam headlights

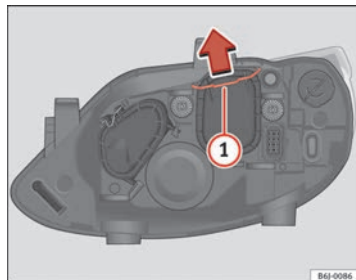

Fig. 161 Dipped beam headlights

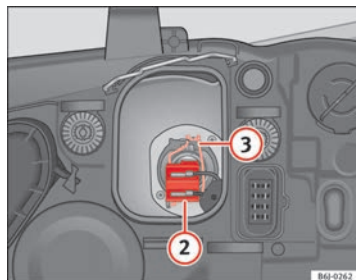

Fig. 162 Dipped beam headlights

- Raise the bonnet.
- Move the loop ⇒ Fig. 161 ① in the direction of the arrow and remove the cover.

- Remove connector ⇒ Fig. 162 ② from the bulb.
- Unclip the retainer spring ⇒ Fig. 162 ③ pressing inwards to the right.
- Extract the bulb and fit the replacement so that the rim of the attachment plate is on the reflector cut-out.
- Fit the connector.
- Fit the cover and close the strap. Make sure that the gasket sits well on the casing cover during the operation.
- Check whether the new bulb is working. ■

Turn signal lights

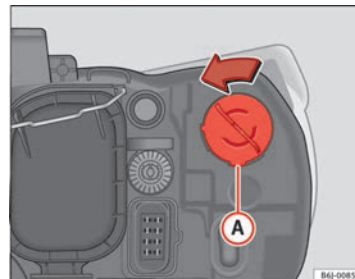

Fig. 163 Turn signal

- Raise the bonnet.
- Turn bulb holder ⇒ Fig. 163 ① to the left and pull. ▶

- Remove the bulb by pressing on the bulb holder and rotating at the same time to the left.
- Installation involves the above steps in reverse sequence. ■

Changing the bulbs of AFS headlights

AFS headlight bulbs

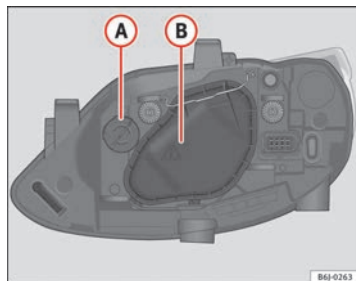

Fig. 164 AFS headlight bulbs

- Ⓐ Turn signal lights
- Ⓑ Xenon headlight (dipped beam/main beam)

Changing the xenon bulb

The procedure for changing the bulb is the same on both sides of the vehicle.



WARNING

This type of bulb should be changed at a specialised workshop. ■

Turn signal light bulb

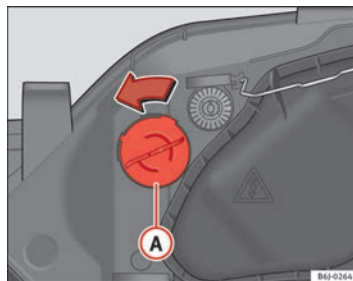

Fig. 165 Turn signal

- Raise the bonnet.
- Turn bulb holder ⇒ Fig. 165 Ⓐ to the left and pull.
- – Remove the bulb by pressing on the bulb holder and rotating at the same time to the left.
- Installation involves the above steps in reverse sequence. ■

Changing the fog light bulbs

Fog light bulb

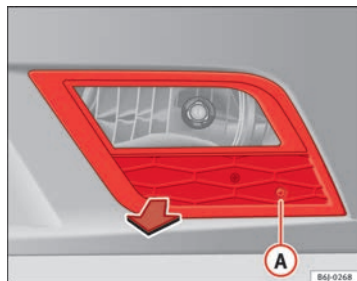

Fig. 166 Fog light

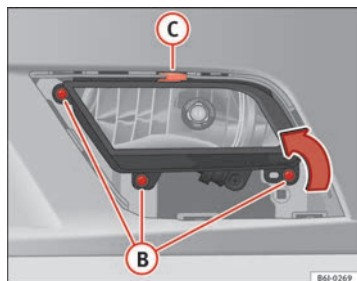

Fig. 167 Fog light

- Remove the bolt ⇒ Fig. 166 **A** from the fog light grille with a screwdriver.
- Subsequently, remove the clips located on the edge of the grill with gentle leverage.
- Remove the bolts (3x) ⇒ Fig. 167 **B** to remove the fog light.
- Remove the metal clip situated on the upper part of the fog light pulling towards the exterior of the vehicle ⇒ Fig. 167 **C**. ■

Remove the bulb holder

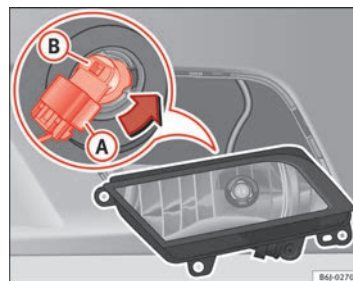

Fig. 168 Fog light

- Remove connector ⇒ Fig. 168 **A** from the bulb.
- Turn bulb holder ⇒ Fig. 168 **B** to the left and pull.
- Remove the bulb by pressing on the bulb holder and turning it anti-clockwise at the same time. ▶

- Installation involves the above steps in reverse sequence.
- Check that the bulb works properly.

Changing the rear lights (on the wing)

Overview of tail lights

Tail lights on side panel Bulb lamps

- Brake lights
- Side lights
- Turn signal

Tail lights on side panel LED lamps

- Brake lights (LEDS)
- Side lights (LEDS)
- Turn signal

Accessing the side light bulbs

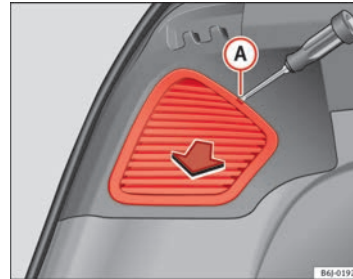

Fig. 169 Side lights

- Open the rear lid.
- Look for a lid with a grill behind the side lights.
- Remove the lid with a flat screwdriver, placing it in notch **A**
⇒ Fig. 169.

Changing bulbs

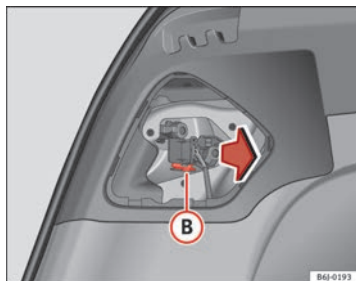

Fig. 170 Removing the bulb holder

- Remove the bulb holder by pressing the clip (B) ⇒ Fig. 170 and pulling outwards.
- Replace the faulty bulb, rotating it to the left and outwards.
- To refit follow the steps in reverse order, taking special care when fitting the bulb holder.

Changing bulbs. LED lamps

Carry out the same operations as in lights fitted with bulbs.

If necessary, remove the socket, as if it were a bulb.

If the brake light and/or side light with LEDs have to be replaced, the tail light must be replaced. ■

Changing the rear lights (on the rear lid)

Overview of tail lights

Lights on the rear lid Bulb lamps

- Reverse lights
- Side lights
- Fog lights

Lights on the rear lid LED lamps

- Reverse lights
- Side lights (LEDs)
- Fog lights

Accessing the rear lid lights

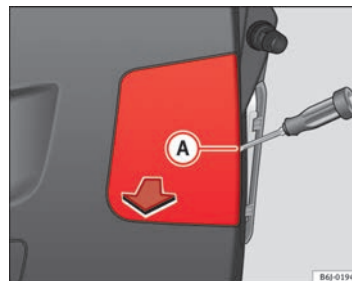

Fig. 171 Lights on the rear lid

- Open the rear lid. ▶

- On the rear lid lining there is a lid behind each light.
- Remove the lid with a flat screwdriver, placing it in notch **(A)**
⇒ Fig. 171.

Changing bulbs

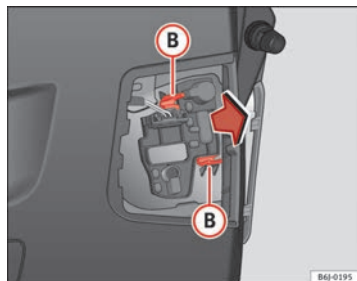

Fig. 172 Removing the bulb holder

- Remove the bulb holder by pressing the fastening clips **(B)**
⇒ Fig. 172 and pulling outwards.
- Replace the faulty bulb, rotating it to the left and outwards.
- To refit follow the steps in reverse order, taking special care when fitting the bulb holder.

Changing bulbs. LED lamps

Carry out the same operations as in lights fitted with bulbs.

If necessary, remove the socket, as if it were a bulb.

If the brake light and/or side light with LEDs have to be replaced, the tail light must be replaced.

Side turn signal bulbs

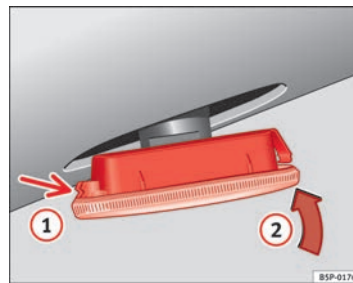

Fig. 173 Side turn signals

- Press the turn signal to the left or to the right to remove the bulb.
- Remove the bulb holder from the turn signal.
- Remove the failed bulb and replace with a new bulb.
- Insert the bulb holder in the turn signal guide until it clicks into place.
- First fit the turn signal in the opening in the chassis, fastening the tabs **(1)** ⇒ Fig. 173, and then fit in the bulb as shown by the arrow **(2)** ⇒ Fig. 173.

Number plate light

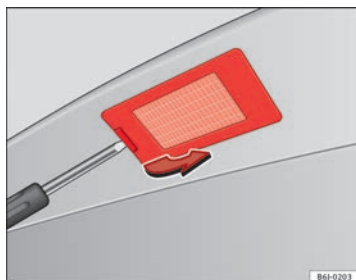

Fig. 174 Remove the number plate light.

- Insert the flat part of a screwdriver into the special slot and remove the number plate light from its moulding.
- Remove the connector and extract the bulb. After changing the bulb, fit the connector again.
- Place the light in its moulding, pressing the left side. Once it is fitted into place, press the right side until you hear a click. ■

Interior light and front reading lights

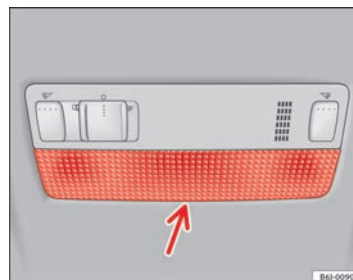

Fig. 175 Front reading light

To remove the glass

- Insert a fine screwdriver between the casing and the glass
⇒ Fig. 175.
- Carefully remove the glass, levering it to avoid possible damage.

To replace the bulbs

- Pull the bulbs outwards.
- To remove the central bulb, hold and press to one side.

Assembly

- Proceed in the reverse order, pressing gently on the outer edge of the side light. ▶

- First fit the glass with the fastening tabs over the frame of the switch. Next press the front part until the two long tabs click on the support. ■

Additional brake lights*

Given the difficulty involved in the replacement of this light it should be done by the Technical Service. ■

Luggage compartment light

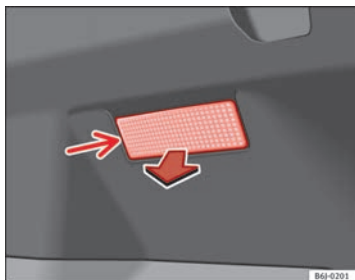

Fig. 176 Luggage compartment light

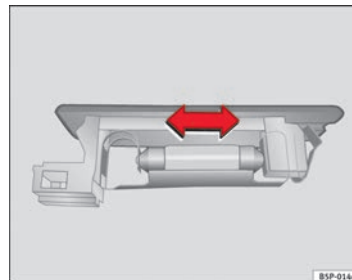

Fig. 177 Luggage compartment light

- Extract the tulip shaped fitting by pressing on the inside edge of this -arrow- using the flat side of a screwdriver ⇒ Fig. 176.
- Press the bulb sideways and remove it from its housing ⇒ Fig. 177. ■

Jump-starting

Jump leads

The jump lead must have a sufficient wire cross section.

If the engine fails to start because of a discharged battery, the battery can be connected to the battery of another vehicle to start the engine. ►

Jump leads

Jump leads must comply with standard **DIN 72553** (see cable manufacturer's instructions). The wire cross section must be at least 25 mm² for petrol engines and at least 35 mm² for diesel engines.

Note

- The vehicles must not touch each other, otherwise electricity could flow as soon as the positive terminals are connected.
- The discharged battery must be properly connected to the on-board network.

How to jump start: description

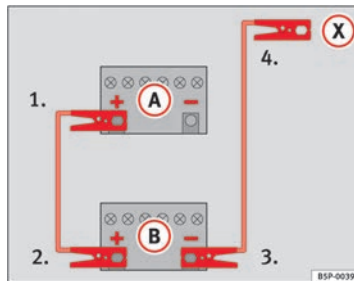

Fig. 178 Diagram of connections for vehicles without Start-Stop system

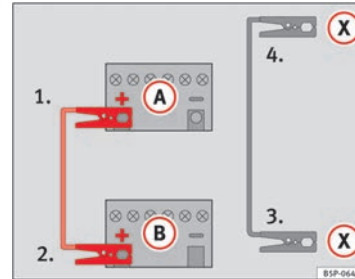



Fig. 179 Diagram of connections for vehicles with Start-Stop system

Jump lead terminal connections

1. Switch off the ignition of both vehicles ⇒ .
2. **For vehicles without Start-Stop system:**
 - Connect one end of the *red* jump lead to the positive (+) terminal of the vehicle with the flat battery (A) ⇒ Fig. 178.
 - Connect the other end of the *red* jump lead to the positive terminal (+) in the vehicle providing assistance (B).
 - Connect one end of the *black* jump lead to the negative terminal (-) of the vehicle providing assistance (B) ⇒ Fig. 178.
 - Connect the other end of the *black* jump lead (X) to a solid metal component bolted to the engine block or to the engine block itself of the vehicle with the flat battery. However, connect it to a point as far as possible from the battery (A).
3. **For vehicles with Start-Stop system:** 

- Connect one end of the *red* jump lead to the positive (+) terminal of the vehicle with the flat battery (A) ⇒ Fig. 179.
 - Connect the other end of the *red* jump lead to the positive terminal (+) in the vehicle providing assistance (B).
 - Connect one end of the *black* jump lead (X) to a suitable ground terminal, a solid piece of metal in the engine block, or to the engine block ⇒ Fig. 179.
 - Connect the other end of the *black* jump lead (X) to a solid metal component bolted to the engine block or to the engine block itself of the vehicle with the flat battery. However, connect it to a point as far as possible from the battery (A).
4. Position the leads in such a way that they cannot come into contact with any moving parts in the engine compartment.

Starting

5. Start the engine of the vehicle with the boosting battery and let it run at idling speed.
6. Start the engine of the vehicle with the flat battery and wait two or three minutes until the engine is “running”.

Removing the jump leads

7. Before you remove the jump leads, switch off the dipped beam headlights (if they are switched on).
8. Turn on the heater blower and heated rear window in the vehicle with the flat battery. This helps minimise voltage peaks which are generated when the leads are disconnected.
9. When the engine is running, disconnect the leads in reverse order to the details given above.

Connect the battery clamps so they have good metal-to-metal contact with the battery terminals.

If the engine fails to start, switch off the starter after about 10 seconds and try again after about half a minute.



WARNING

- Please note the safety warnings referring to working in the engine compartment ⇒ page 200, Working in the engine compartment.
- The battery providing assistance must have the same voltage as the flat battery (12V) and approximately the same capacity (see imprint on battery). Failure to comply could result in an explosion.
- Never use jump leads when one of the batteries is frozen. Danger of explosion! Even after the battery has thawed, battery acid could leak and cause chemical burns. If a battery freezes, it should be replaced.
- Keep sparks, flames and lighted cigarettes away from batteries, danger of explosion. Failure to comply could result in an explosion.
- Observe the instructions provided by the manufacturer of the jump leads.
- Do not connect the negative cable from the other vehicle directly to the negative terminal of the flat battery. The gas emitted from the battery could be ignited by sparks. Danger of explosion.
- Do not attach the negative cable from the other vehicle to parts of the fuel system or to the brake line.
- The non-insulated parts of the battery clamps must not be allowed to touch. The jump lead attached to the positive battery terminal must not touch metal parts of the vehicle, this can cause a short circuit.
- Position the leads in such a way that they cannot come into contact with any moving parts in the engine compartment.
- Do not lean on the batteries. This could result in chemical burns. ▶

**Note**

The vehicles must not touch each other, otherwise electricity could flow as soon as the positive terminals are connected. ■

Towing and tow-starting

Tow-starting*

The use of jump leads is preferable to tow-starting.

We recommend that you do **not** tow-start your vehicle. Jump-starting is preferable ⇒ page 248.

However, if your vehicle has to be tow-started:

- Engage the 2nd or the 3rd gear.
- Keep the clutch pressed down.
- Switch the ignition on.
- Once both vehicles are moving, release the clutch.
- As soon as the engine starts, press the clutch and move the gear lever into neutral. This helps to prevent driving into the towing vehicle.



WARNING

The risk of accidents is high when tow-starting. The vehicle being towed can easily collide with the towing vehicle.



CAUTION

When tow-starting, fuel could enter the catalytic converter and damage it. ■

Comments

Please observe the following points if you use a tow rope:

Notes for the driver of the towing vehicle

- Drive slowly at first until the tow rope is taut. Then accelerate gradually.
- Begin and change gears cautiously. If you are driving an automatic vehicle, accelerate gently.
- Remember that the brake servo and power steering are not working in the vehicle you are towing. Brake sooner than normal and pressing the pedal gently.

Notes for the driver of the towed vehicle

- Ensure that the tow rope remains taut at all times when towing.

Tow rope or tow bar

It is easier and safer to tow a vehicle with a tow bar. You should only use a tow rope if you do not have a tow bar.

A tow rope should be slightly elastic to reduce the loading on both vehicles. It is advisable to use a tow rope made of synthetic fibre or similarly elastic material.

Attach the tow rope or the tow bar only to the towline anchorages provided or a towing bracket.

Driving style

Towing requires some experience, especially when using a tow rope. Both drivers should be familiar with the technique required for towing. Inexperienced drivers should not attempt to tow. ►

Do not pull too hard with the towing vehicle and take care to avoid jerking the tow rope. When towing on an unpaved road, there is always a risk of overloading and damaging the anchorage points.

The ignition of the vehicle being towed must be switched on to prevent the steering wheel from locking and also to allow the use of the turn signals, horn, windscreen wipers and washers.

As the brake servo does not work if the engine is not running, you must apply considerably more pressure to the brake pedal than you normally would.

As the power assisted steering does not work if the engine is not running, you will need more strength to steer than you normally would.

Towing vehicles with an automatic gearbox

- Put the selector lever into position "N".
- Do not drive faster than 50 km/h (30 mph).
- Do not tow further than 50 km (30 miles).
- If a breakdown vehicle is used, the vehicle must be towed with the front wheels raised.



Note

- Observe legal requirements when towing or tow-starting.
- Switch on the hazard warning lights of both vehicles. However, observe any regulations to the contrary.
- For technical reasons, vehicles with an automatic gearbox must not be tow-started.
- If damage to your vehicle means that there is no lubricant in the gearbox, you must raise the driven wheels while the vehicle is being towed.
- If the vehicle has to be towed more than 50 km (30 miles), the front wheels should be raised during towing, and towing should be carried out by a qualified person.

- The steering wheel is locked when the vehicle has no electrical power. The vehicle must then be towed with the front wheels raised. Towing should be carried out by a qualified person.
- The towline anchorage should always be kept in the vehicle. ■

Towline anchorages

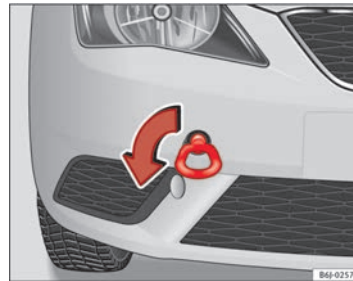

Fig. 180 Fitting the towline anchorage to front of the vehicle

Fitting the towline anchorage

- Take the towline anchorage from the on-board tool set.
- Remove the front cover by pressing down on its left-hand side. For FR finishes, press down and pull outwards.
- Bolt the anchorage to its limit to the *left*, in the direction of the arrow ⇒ Fig. 180. ■

Rear towline anchorage

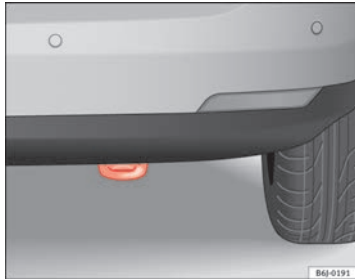

Fig. 181 Rear towline anchorage

There is a towline anchorage at the rear on the right below the rear bumper. ■

Technical Specifications

Description of specifications

Important information

Important

The information in your vehicle's official documents always take precedence over the information in the current instruction manual.

All technical specifications provided in this documentation are valid for the standard model in Spain. The vehicle data card included in the Maintenance Programme or the vehicle registration documentation shows which engine is installed in the vehicle.

The figures may be different depending whether additional equipment is fitted, for different models, for special vehicles and for other countries.

Abbreviations used in the Technical Specifications section

Abbreviation	Meaning
kW	Kilowatt, engine power measurement.
PS	Pferdestärke (horsepower), formerly used to denote engine power.
rpm	Revolutions per minute - engine speed.
Nm	Newton metres, unit of engine torque.
l/100 km	Fuel consumption in litres per 100 km.
g/km	Carbon dioxide emissions in grams per km travelled.
CO ₂	Carbon dioxide

Abbreviation	Meaning
CN	Cetane number, indication of the diesel combustion power.
RON	Research octane number, indication of the knock resistance of petrol.

Vehicle identification data

The most important information is given on the identification plate and the vehicle data sticker.

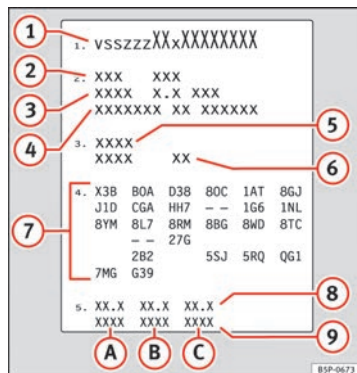

Fig. 182 Vehicle data sticker (luggage compartment)

Vehicles for certain export countries do not have an identification plate.

Identification plate

The identification plate is located on the right rib inside the engine compartment.

Vehicle identification number

The vehicle identification number (chassis number) can be read from outside the vehicle through a viewer in the windscreen. This is located on the left-hand side of the vehicle in the lower area of the windscreen. It is also located on the right hand side of the engine compartment.

Vehicle data

The data sticker is placed on the inside of the spare wheel well, in the luggage compartment and on the rear cover of the Maintenance Programme.

The following information is provided on the vehicle data sticker: ⇒ Fig. 182

- ① Production control number
- ② Vehicle identification number (chassis number)
- ③ Model code number
- ④ Model designation/engine power output
- ⑤ Engine and gearbox code letters
- ⑥ Paintwork number/interior trim code
- ⑦ Optional equipment codes
- ⑧ Consumption values
- ⑨ CO₂ emissions values

At the end of the data sticker, in points ⑧ and ⑨, you can see the consumption and emission information.

Information on consumption and emissions

- Ⓐ Urban consumption (l/100 km)
Urban CO₂ emissions (g/km)
- Ⓑ Extra-urban consumption (l/100 km)
Extra-urban CO₂ emissions (g/km)
- Ⓒ Combined consumption (l/100 km)
Combined CO₂ emissions (g/km)

Information on fuel consumption

Fuel consumption

The consumption and emission details shown on the vehicle data sticker differ from one vehicle to another.

The vehicle fuel consumption and CO₂ emissions can be consulted on the vehicle data sticker in the spare wheel well, inside the luggage compartment and on the rear cover of the Maintenance Programme.

The fuel consumption and CO₂ emission values refer to the weight category assigned to your vehicle according to the engine and gearbox combination, as well as the specific equipment fitted, and is only used to compare between the different models.

The fuel consumption and CO₂ emissions do not depend only on the performance of the vehicle, they can also differ from the established values depending on other factors such as driving style, road conditions, traffic conditions, environmental conditions, load and number of passengers.

Calculation of fuel consumption

The consumption values have been calculated based on measurements performed or supervised by certified CE laboratories according to the latest version of directives 715/2007/EC and 80/1268/CEE (for more information consult the European Union Publications Office at EUR-Lex: © European Union, <http://eur-lex.europa.eu/en/index.htm>) and are valid for the kerb weight indicated for the vehicle.



Note

In practice, and considering all the factors mentioned here, consumption values can differ from those calculated in the current European regulations. ■

Weights

Kerb weight refers to the basic model with a fuel tank filled to 90% capacity and without optional extras. The figure quoted includes 75 kg to allow for the weight of the driver.

For special versions and optional equipment fittings or for the addition of accessories, the weight of the vehicle will increase ⇒ ⚠.



WARNING

- **Please note that the centre of gravity may shift when transporting heavy objects; this may affect vehicle handling and lead to an accident. Always adjust your speed and driving style to suit road conditions and requirements.**
- **Never exceed the gross axle weight rating or the gross vehicle weight rating. If the allowed axle load or the allowed total weight is exceeded, the driving characteristics of the vehicle may change, leading to accidents, injuries and damage to the vehicle.**

Towing a trailer

Trailer weights

Trailer weight

The trailer weights and drawbar loads approved are selected in intensive trials according to precisely defined criteria. The approved trailer weights are valid for vehicles in the *EU* for maximum speeds of 80 km/h (50 mph) (in certain circumstances up to 100 km/h (60 mph)). The figures may be different in other countries. All data in the official vehicle documentation takes precedence over these data at all times ⇒ ⚠. ▶

Drawbar loads

The *maximum* permitted drawbar load on the ball joint of the towing bracket must not exceed **75 kg**.

In the interest of road safety, we recommend that you always tow approaching the maximum drawbar load. The response of the trailer on the road will be poor if the drawbar load is too small.

If the maximum permissible drawbar load cannot be met (e.g. with small, empty and light-weight single axle trailers or tandem axle trailers with a wheelbase of less than 1 metre), a minimum of 4% of the actual trailer weight is legally required for the drawbar load.

WARNING

- For safety reasons, do not exceed the **80 km/h (50 mph) limit**. This is also valid in countries where higher speeds are permitted.
- Never exceed the maximum trailer weights or the drawbar load. If the permissible axle load or the permissible total weight is exceeded, the driving characteristics of the vehicle may change, leading to accidents, injuries and damage to the vehicle.

Wheels

Tyre pressure, snow chains, wheel bolts

Tyre pressures

The sticker with the tyre pressure values can be found on the inside of the fuel tank flap. The tyre pressure values given there are for *cold* tyres. The slightly raised pressures of warm tyres must not be reduced. ⇒ 

Snow chains

Snow chains may be fitted only to the front wheels, and only for the following tyres:

175/70R14 185/60R15	Chains with links not exceeding 15 mm (including the chain closure)
215/45R16	Chains with links not exceeding 9 mm (including the chain closure)
215/40R17	Chains with links not exceeding 7 mm (including the chain closure)

Wheel bolts

After the wheels have been changed, the **tightening torque** of the wheel bolts should be checked as soon as possible with a torque wrench ⇒ . The tightening torque for steel and alloy wheels is **120 Nm**.

WARNING

- Check the tyre pressure at least once per month. Checking the tyre pressure is very important. If the tyre pressure is too high or too low, there is an increased danger of accidents, particularly at high speeds.
- If the tightening torque of the wheel bolts is too low, they could loosen while the vehicle is in motion. Risk of accident! If the tightening torque is too high, the wheel bolts and threads can be damaged.



Note

We recommend that you ask your Technical Service for information about appropriate wheel, tyre and snow chain size.

Technical specifications

Checking fluid levels

From time to time, the levels of the different fluids in the vehicle must be checked. Never fill with incorrect fluids, otherwise serious damage to the engine may be caused.

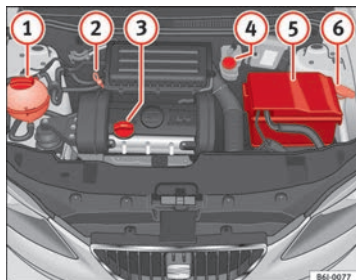

Fig. 183 Diagram for the location of the various elements

- ① Coolant expansion tank
- ② Engine oil level dipstick
- ③ Engine oil filler cap
- ④ Brake fluid reservoir
- ⑤ Vehicle battery
- ⑥ Windscreen washer fluid container

The checking and refilling of service fluids are carried out on the components mentioned above. These operations are described in the ⇒ page 200.

Overview

You will find further explanations, instructions and restrictions on the technical specifications as of ⇒ page 255.



Note

The layout of parts may vary depending on the engine. ■

Petrol engine 1.2 51 kW (70 PS)

Engine specifications

Power output in kW (PS)	rpm	51 (70)/ 5400
Maximum torque	in Nm at rpm	112/ 3000
No. of cylinders/capacity	in cm ³	3/ 1198
Fuel		Super 95 RON ^{a)} /Normal 91 RON ^{b)}

a) Research Octane Number = Anti-detonation rating of the petrol.

b) Slight power loss.

Performance

Maximum speed	in km/h (mph)	163
Acceleration from 0-80 km/h (0-50 mph)	in sec.	9,4
Acceleration from 0-100 km/h (0-60 mph)	in sec.	14,6

Weights

Gross vehicle weight	in kg	1605
Weight in running order (with driver)	in kg	1110
Gross front axle weight	in kg	830
Gross rear axle weight	in kg	820
Permitted roof load	in kg	75

Trailer weight

Trailer without brakes	550
Trailer with brakes, gradients up to 8%	1000
Trailer with brakes, gradients up to 12%	800

Petrol engine 1.2 TSI 63 kW (85 PS)

Engine specifications

Power output in kW (PS)	rpm	63 (85) / 4800
Maximum torque	in Nm at rpm	160 / 1500-3500
No. of cylinders/capacity	in cm ³	4 / 1197
Fuel		Super 95 RON ^{a)} /Normal 91 RON ^{b)}

a) Research Octane Number = Anti-detonation rating of the petrol.

b) Slight power loss.

Performance

Maximum speed	in km/h (mph)	180
Acceleration from 0-80 km/h (0-50 mph)	in sec.	7,7
Acceleration from 0-100 km/h (0-60 mph)	in sec.	11,7

Weights

Gross vehicle weight	in kg	1600
Weight in running order (with driver)	in kg	1145
Gross front axle weight	in kg	860
Gross rear axle weight	in kg	820
Permitted roof load	in kg	75

Trailer weight

Trailer without brakes	in kg	570
Trailer with brakes, gradients up to 8%	in kg	1200
Trailer with brakes, gradients up to 12%	in kg	1200

Petrol engine 1.4 63 kW (85 PS)

Engine specifications

Power output in kW (PS)	rpm	63 (85)/ 5000
Maximum torque	in Nm at rpm	132/ 3800
No. of cylinders/capacity	in cm ³	4/ 1390
Fuel		Super 95 RON ^{a)} /Normal 91 RON ^{b)}

a) Research Octane Number = Anti-detonation rating of the petrol.

b) Slight power loss.

Performance

Maximum speed	in km/h (mph)	177
Acceleration from 0-80 km/h (0-50 mph)	in sec.	8
Acceleration from 0-100 km/h (0-60 mph)	in sec.	12,4

Weights

Gross vehicle weight	in kg	1605
Weight in running order (with driver)	in kg	1130
Gross front axle weight	in kg	840
Gross rear axle weight	in kg	820
Permitted roof load	in kg	75

Trailer weight

Trailer without brakes	560
Trailer with brakes, gradients up to 8%	1200
Trailer with brakes, gradients up to 12%	1000

Petrol engine 1.2 TSI 77 kW (105 PS)

Engine specifications

Power output in kW (PS)	rpm	77 (105)/5000
Maximum torque	in Nm at rpm	175/1550-4100
No. of cylinders/capacity	in cm ³	4/ 1197
Fuel		Super 95 RON ^{a)} /Normal 91 RON ^{b)}

a) Research Octane Number = Anti-detonation rating of the petrol.

b) With a slight power loss

Performance

		Manual	Automatic
Maximum speed	in km/h (mph)	190	190
Acceleration from 0-80 km/h (0-50 mph)	in sec.	6,8	6,7
Acceleration from 0-100 km/h (0-60 mph)	in sec.	10,2	10

Weights

		Manual	Automatic
Gross vehicle weight	in kg	1605	1630
Weight in running order (with driver)	in kg	1145	1165
Gross front axle weight	in kg	860	890
Gross rear axle weight	in kg	820	820
Permitted roof load	in kg	75	75

Trailer weight

	Manual	Automatic
Trailer without brakes	570	580
Trailer with brakes, gradients up to 8%	1200	1200
Trailer with brakes, gradients up to 12%	1200	1200

Petrol engine 1.2 TSI 77 kW (105 PS) Start-Stop

Engine specifications

Power output in kW (PS)	rpm	77 (105)/ 5000
Maximum torque	in Nm at rpm	175/1550-4100
No. of cylinders/capacity	in cm ³	4/ 1197
Fuel		Super 95 RON ^{a)} /Normal 91 RON ^{b)}

a) Research Octane Number = Anti-detonation rating of the petrol.

b) Slight power loss.

Performance

Maximum speed	in km/h (mph)	190
Acceleration from 0-80 km/h (0-50 mph)	in sec.	6,8
Acceleration from 0-100 km/h (0-60 mph)	in sec.	10,2

Weights

Gross vehicle weight	in kg	1605
Weight in running order (with driver)	in kg	1150
Gross front axle weight	in kg	860
Gross rear axle weight	in kg	820
Permitted roof load	in kg	75

Trailer weight

Trailer without brakes	570
Trailer with brakes, gradients up to 8%	1200
Trailer with brakes, gradients up to 12%	1200

Petrol engine 1.4 TSI 110 kW (150 PS) automatic

Engine specifications

Power output in kW (PS)	rpm	110 (150)/ 5800
Maximum torque	in Nm at rpm	220/1250-4500
No. of cylinders/capacity	in cm ³	4/ 1390
Fuel		Super 95 RON ^{a)} /Normal 91 RON ^{b)}

a) Research Octane Number = Anti-detonation rating of the petrol.

b) Slight power loss.

Performance

Maximum speed	in km/h (mph)	212
Acceleration from 0-80 km/h (0-50 mph)	in sec.	5,7
Acceleration from 0-100 km/h (0-60 mph)	in sec.	8

Weights

Gross vehicle weight	in kg	1735
Weight in running order (with driver)	in kg	1280
Gross front axle weight	in kg	950
Gross rear axle weight	in kg	820
Permitted roof load	in kg	75

Trailer weight

Trailer without brakes	640
Trailer with brakes, gradients up to 8%	1300
Trailer with brakes, gradients up to 12%	1200

Diesel engine 1.2 TDI CR 55 kW (75 PS) DPF Start-Stop Ecomotive

Engine specifications

Power output in kW (PS)	rpm	55 (75)/ 4200
Maximum torque	in Nm at rpm	180/ 2000
No. of cylinders/capacity	in cm ³	3/ 1199
Fuel		min. diesel compliant with DIN EN 590 51 CN ^{a)}

a) Cetane Number (cetane index) = Measure of the diesel combustion power.

Performance

Maximum speed	in km/h (mph)	173
Acceleration from 0-80 km/h (0-50 mph)	in sec.	9,5
Acceleration from 0-100 km/h (0-60 mph)	in sec.	14,6

Weights

Gross vehicle weight	in kg	1680
Weight in running order (with driver)	in kg	1205
Gross front axle weight	in kg	900
Gross rear axle weight	in kg	820
Permitted roof load	in kg	75

Trailer weight

Trailer without brakes	600
Trailer with brakes, gradients up to 8%	1200
Trailer with brakes, gradients up to 12%	1000

Diesel engine 1.2 TDI CR 55 kW (75 PS) DPF

Engine specifications

Power output in kW (PS)	rpm	55 (75)/ 4200
Maximum torque	in Nm at rpm	180/ 2000
No. of cylinders/capacity	in cm ³	3/ 1199
Fuel		min. diesel compliant with DIN EN 590 51 CN ^{a)}

^{a)} Cetane Number (cetane index) = Measure of the diesel combustion power.

Performance

Maximum speed	in km/h (mph)	168
Acceleration from 0-80 km/h (0-50 mph)	in sec.	9,5
Acceleration from 0-100 km/h (0-60 mph)	in sec.	14,5

Weights

Gross vehicle weight	in kg	1680
Weight in running order (with driver)	in kg	1205
Gross front axle weight	in kg	900
Gross rear axle weight	in kg	820
Permitted roof load	in kg	75

Trailer weight

Trailer without brakes	590
Trailer with brakes, gradients up to 8%	1200
Trailer with brakes, gradients up to 12%	1000

Diesel engine 1.6 TDI CR 66 kW (90 PS) DPF

Engine specifications

Power output in kW (PS)	rpm	66 (90)/ 4200
Maximum torque	in Nm at rpm	230/ 1500-2500
No. of cylinders/capacity	in cm ³	4/ 1598
Fuel		min. diesel compliant with DIN EN 590 51 CN ^{a)}

a) Cetane Number (cetane index) = Measure of the diesel combustion power.

Performance

Maximum speed	in km/h (mph)	178
Acceleration from 0-80 km/h (0-50 mph)	in sec.	8
Acceleration from 0-100 km/h (0-60 mph)	in sec.	12,2

Weights

Gross vehicle weight	in kg	1680
Weight in running order (with driver)	in kg	1225
Gross front axle weight	in kg	930
Gross rear axle weight	in kg	820
Permitted roof load	in kg	75

Trailer weight

Trailer without brakes	610
Trailer with brakes, gradients up to 8%	1200
Trailer with brakes, gradients up to 12%	1200

Diesel engine 1.6 TDI CR 77 kW (105 PS) with/without DPF

Engine specifications

Power output in kW (PS)	rpm	77 (105)/ 4400
Maximum torque	in Nm at rpm	250/ 1500-2500
No. of cylinders/capacity	in cm ³	4/ 1598
Fuel		min. diesel compliant with DIN EN 590 51 CN ^{a)}

^{a)} Cetane Number (cetane index) = Measure of the diesel combustion power.

Performance

Maximum speed	in km/h (mph)	188
Acceleration from 0-80 km/h (0-50 mph)	in sec.	7,3
Acceleration from 0-100 km/h (0-60 mph)	in sec.	10,9

Weights

Gross vehicle weight	in kg	1680
Weight in running order (with driver)	in kg	1225
Gross front axle weight	in kg	930
Gross rear axle weight	in kg	820
Permitted roof load	in kg	75

Trailer weight

Trailer without brakes	1200
Trailer with brakes, gradients up to 8%	1200
Trailer with brakes, gradients up to 12%	1200

Dimensions and capacities

Dimensions		
Length, width	4236 mm/1693 mm	
Height at kerb weight (with bars)	1445 mm	
Front and rear projection	857 mm/910 mm	
Wheelbase	2469 mm	
Turning circle	10.7 m	
Track width ^{a)}	Front	Rear
	1465 mm	1457 mm
Capacities		
Fuel tank	45 l. Reserve 7 l.	
Windscreen washer fluid container with headlight washer	2 l/4.5 l	
Tyre pressure		
Summer-grade tyres:		
The correct tyre pressure can be seen on the sticker on the inside of the tank flap.		
Winter tyres:		
The pressure of these tyres is the same as the summer tyre pressure plus 0.2 bar.		

^{a)} This data will change depending on the type of wheel rim. ■

Index

A

- ABS 169
 - control lamp 71
 - Accessories 190
 - Acoustic warning 145
 - Adaptive headlights 103
 - AFS headlight bulbs 242
 - Airbag covers 36
 - Airbag system 30
 - control lamp 31
 - Front airbags 34
 - side airbags 38
 - Air conditioner
 - Climatronic 140
 - General notes 142
 - Air conditioning* 137
 - Air outlets 136
 - Air recirculation
 - Semi-automatic air conditioning 139
 - Air recirculation mode
 - Climatronic 142
 - Alarm system
 - Switching off 90
 - Alternator
 - Warning lamp 76
 - Anti-lock brake system 169
 - control lamp 71
 - Anti-theft alarm system 90
 - Switching off 90
 - Anti-theft wheel bolts 226
 - Antifreeze 207
 - Aquaplaning 219
 - Ashtray 125
 - Aspects to note before setting off 8
 - ASR 169
 - ASR (Traction control system)
 - Control lamp 72
 - Audible warning 20
 - Automatic anti-dazzle interior mirror
 - Deactivating the anti-dazzle function 112
 - Automatic anti-dazzle interior mirror*
 - Activating the anti-dazzle function 112
 - Automatic car washing tunnel 182
 - Automatic gearbox 154
 - Kick-down feature 160
 - Selector lever positions 158
 - Automatic lighting 101
 - Automatic windscreen wiper/washer 109
 - AUX/USB input connection 127
 - Auxiliary audio input connection (AUX) 127
- ### B
- Ball coupling 179
 - Battery
 - Changing 216
 - Charging 216
 - Winter conditions 214
 - Before setting off 8
 - Belt tensioners 28
 - Biodiesel 199
 - Biodiesel fuel 199
 - Bonnet 202
 - Brake fluid 213
 - Changing 213
 - Brake pads 173
 - Brakes 173
 - Brake servo 168, 173
 - Brake system 213
 - warning lamp 73
 - Braking distance 173
 - Bulb change
 - double headlight 238
 - Single headlight bulb 236
 - Bulb changes
 - General notes 234
 - Bulb defect
 - Control lamp 71
 - Buzzer 107, 145

C

Car care			
Exterior	182		
Car phone	191		
Catalytic converter	174		
CCS	164		
Central lock button			
Locking	85		
Unlocking	85		
Central locking	82		
Automatic speed dependent locking and unlocking system*	84		
Emergency unlocking system	85		
Locking system for involuntary unlocking	84		
Selective unlocking system*	83		
Unlocking system*	84		
Cetane number	199		
Changing bulbs			
interior light and front reading lights	247		
Changing gear			
see Manual gearbox	153		
Changing gear in tiptronic mode	157		
Changing rear lights			
on the rear lid	245		
on the wing	244		
Changing single headlight bulbs			
Turn signal bulb	236		
Changing the AFS headlight bulbs			
Xenon lights	242		
Changing the bulbs			
AFS headlight bulbs	242		
fog light bulbs	243		
Luggage compartment light	248		
number plate light	247		
Side turn signal lights	246		
Changing the main headlight bulb			
turn signal lights	240		
Changing the main headlight bulbs			
turn signal lights	242		
Changing the single headlight bulbs			
Dipped/main beam	237		
Side light	237		
Changing windscreen wiper blades	210		
Chassis number	256		
Checking	215		
Checking battery electrolyte level	215		
Checking engine oil level	205		
Child safety	43		
Child seat			
Categorisation in groups	45		
Group 1	46		
Group 2	46		
Group 3	46		
Groups 0 and 0+	45		
Safety notes	43		
Securing	48		
Child seats	45		
ISOFIX system	49		
on the front passenger seat	31		
Top Tether system	50		
Cigarette lighter	126		
Cleaning alloy wheel rims	186		
Cleaning chrome	185		
Cleaning engine compartment	187		
Cleaning steel wheel rims	186		
Cleaning windows	184		
Climatronic			
automatic mode	141		
controls	140		
General notes	142		
manual mode	141		
Clock	60		
Cloth seat covers cleaning	188		
Cockpit	55		
Coming Home function	104		
Compartment for on-board documentation	122		
Control			
Exterior mirrors	113		
control lamp	31		
Control lamps	65		
Control lighting	55		
Controls			
Electric windows	95		
Convenience closing			
Sliding/tilting sunroof	99		
Windows	97		
Convenience opening			
Windows	97		
Coolant	207, 208		
Coolant level	208		
control lamp	75		
Coolant loss	208		
Coolant temperature			
control lamp	75		
Safety instructions	76		
Correct adjustment of front head restraints	13		

- Correct sitting position
 front passenger 11
 Incorrect sitting position 14
 passenger 12
- Cruise control
 Control lamp 73
- Cruise control system 164
- Cruise speed 164
 Control lamp 73
- D**
- Danger of fitting a child seat on the front passenger seat 31
- Dash panel 55
- Dash panel cleaning 187
- Daytime driving lights 102
- Deactivating front passenger airbag
 Safety notes 41
- Deactivating the airbag
 Front passenger front airbag 41
- Diesel 199
- Diesel engine 200
 Winter driving 200
- Diesel engine particulate filter 175
- Differential lock 171
- Differential lock fault (EDL)
 control lamp 72
- Digital clock 60
- Dipped beam headlights 100
- Disposal
 Airbags 32
 Seat belt tensioners 28
- Door lock cylinders 185
- Door release lever 55
- Doors
 Childproof locks 86
 control lamp 74
- Double headlight 238
- Double headlight bulb change
 dipped beam headlights 240
 main beam headlights 239
 side light 238
- Driver
see Correct sitting position 10, 11, 12
- Driveshaft differential
 XDS 170
- Drive wheel traction control system 169
- Driving
 Driving abroad 178
 Economically / Environmentally friendly 176
 With a trailer 178, 180
- Driving abroad 178
- Headlights 178
- Driving safety 8
- Duplicate keys 87
- Dust filter 142
- Dynamic headlight range control 102
- E**
- Economical driving 176
- EDL 171
 control lamp 71
- Electro-hydraulic steering
 Control lamp 75
- Electronic differential lock 171
 control lamp 71
- Electronic immobiliser 146
- Electronic Stability Control 72, 170
 description 145
- Electronic Stability Control (ESC)
 control lamp 72
- Emission control system
 control lamp 75
- Engine
 Running in 173
- Engine compartment
 Working in the engine compartment 200
- Engine coolant 207
- G 12 plus-plus 207
- G 13 207
- Specifications 207
- Engine fault
 control lamp 70
- Engine management
 control lamp 69
- Engine oil 203
 Changing 206
 Checking engine oil level 205
 Oil properties 204
 Specifications 203
 Topping up 206
- Engine oil dipstick 205

- Engine oil pressure
 control lamp 70
 Environment 176
 Environmental friendliness 176
 Environmentally friendly driving 177
 Environmental tip
 Avoiding pollution 195
 ESC 72, 170
 see also Electronic Stability Control 145
 Exhaust gas purification system 174
 Exterior mirrors 184
 External aerial 191
- F**
- Fabric trim cleaning 188
 Fastening rings 17
 Fire extinguisher 128
 First-aid kit 128
 Floor mats 16
 Fog lights 100
 Fog lights bulb 243
 Fog lights with cornering function 103
 Front airbags 34
 Description 34
 Operation 35
 Safety notes 37
 Front drink holder 124
 Front interior light 107
 Front passenger airbag deactivation 41
 Front reading light 108
- Front seat adjustment
 Lumbar support 118
 Fuel
 Diesel 199
 Petrol 199
 Fuel consumption 176, 256
 Fuel level
 Indicator 59
 Fuel reserve
 Control lamp 74
 Fuel tank
 see Fuel reserve 74
 Fuel Tank
 Opening the fuel tank flap 194
 Fuel: save 176
 Fuses 231
- G**
- Gear shift pattern 153
 General overview of the engine compartment 259
 Glove compartment 122
 Glove compartment light 108
 Glow plug system 148
 control lamp 70
- H**
- Handbrake 161
 Warning lamp 161
 Hazard warning lights 105
 HBA 168
- Headlight flashers 106
 Headlight range control 102
 Headlights
 Driving abroad 178
 Fog lights 100
 Headlight washer 112
 Head restraints
 Adjusting 116, 117
 Adjustment of the head restraint angle .. 117
 Removing 117
 Heated exterior mirrors* 113
 Heated front seats 119
 Heated rear window
 Heating element wires 185
 Heating 134
 Heating system 135
 High pressure cleaners 183
 Hill-start assist 162
 Horn 55
 How to jump start description 249
 Hydraulic Brake Assist
 Automatic hazard warning lights activa-
 tion 168
- I**
- Identification number 256
 Identification plate 256
 Ignition key 145
 Ignition lock 145
 Information in the multifunction display
 Memory displays 61

Instrument and switch lighting 102
 Instrument lighting 55
 Instrument panel
 Service interval display 63
 Instruments 57
 Interior rear vision mirror 112
 Interval wipe, windscreen 109
 ISOFIX system 49

J

Jump-starting 248
 Jump leads 248

K

Keys 87

L

Leather cleaning 188
 Leaving Home function 104
 Lights 100
 Load compartment in the luggage compartment
 see Loading the luggage compartment ... 16
 Loading the luggage compartment 16
 Locks 185
 LPG 58, 149, 196
 LPG system
 Driving 149
 Filler neck adapter 197

Level indicator 58
 Refuelling 196
 Luggage compartment 129
 Fastening rings 130
 Loading 129
 Luggage net 130
 see also Loading the luggage compartment 16
 Luggage compartment light* 108

M

Main beam 100, 106
 Main beam headlights
 control lamp 75
 Maintenance
 Airbags 32
 Maintenance and cleaning 181
 Manual gearbox 153
 Manual heating 135
 controls 134
 Manual heating system
 Defrosting the windscreen 135
 Demisting the windscreen and side windows 135
 MFI 61
 Mirrors
 Exterior mirrors 113
 Interior rear vision mirror 112
 vanity mirror 109
 Mobile phone 191
 Multifunction display 61

N

Navigator bracket 123
 Number of seats 19

O

Observations 178
 Octane number 199
 Odometer 63
 Oil 203
 Oil change 206
 Oil properties 204
 One-touch opening and closing
 Electric windows 96
 Opening and locking 93
 Operation when a fault occurs
 panoramic/tilting sunroof 99
 Outside temperature indicator 60, 62
 Overview
 Control lamps 65, 67
 Dash panel 55
 Instruments 57
 Warning lamps 65, 67

P

Paintwork
 Polishing 184
 Panoramic sunroof 98
 Parking 162
 Parking lights 106

Passenger see Correct sitting position	10, 11, 12
Pedals	16
Petrol	199
Driving abroad	178
Petrol additives	199
Physical principles of a frontal collision	21
Plastic parts	184
Plastic parts cleaning	187
Pollen filter	142
Pollution filter	142
Power socket	
in centre console	126
in the luggage compartment	127
Products for vehicle maintenance	181

R

Radio frequency remote control	88
Changing the battery	89
Rain sensor*	110
Rear drink holder	125
Rear fog light	
control lamp	71
Control lamp	100
Rear head restraints	14
Rear lid	93
Control lamp	74
Emergency opening	94
Rear seat	
folding down	120
Rear seats	120
Rear shelf	131
Rear shelf with storage compartment	
Storage compartment	132
Rear view mirrors	112
Rear window automatic wiper/washer	111
Rear window wiper	111
Recommended gear display	60
Refuelling	194
Remote control key	
Buttons	88
Synchronising	89
Removing and fitting the wheel	228
Repairs	
Airbags	32
Replacement keys	87
Replacement of parts	190
Rev counter	58
Reverse gear	
Manual gearbox	153
Roll-back function	
panoramic/tilting sunroof	99
Windows	96
Roof aerial*	191
Roof rack*	132
Rubber seals	185
Running in	
Brake pads	173
Engine	173
Tyres	173
Running in tyres	173

S

Safe	82
Safe driving	7
Safe Security system	82
Safety	8
Safety equipment	7
Safety instructions	
Coolant temperature	76
Safety notes	
Airbags	32
Deactivating front passenger airbag	41
Front airbags	37
Seat belt tensioners	28
Side airbags	39
Using child seats	43
Using seat belts	23
Seals	185
Seat adjustment	115, 118
Seat belt cleaning	189
Seat belt control lamp	20
Seat belt position	
Pregnant women	26
Seat belts	26
Seat belt protection	23
Seat belt release	27
Seat belts	19
Adjustment	25
control lamp	20
Incorrectly fastened	28
Not worn	22
Safety notes	23

Seat belt tensioner			
control lamp	31		
Seat heating	119		
Selective opening*	83		
Semiautomatic air conditioning			
controls	137		
Service interval display	63		
Side airbags	38		
Description	38		
Operation	39		
Safety notes	39		
Side lights	100		
Single headlight bulb	236		
Sitting position			
driver	10		
Sitting position, occupants	10		
Snow chains	221, 258		
Soot accumulation in the diesel engine particulate filter			
control lamp	70		
Spanner symbol	64		
Spare parts	190		
Spare wheel	223		
Speedometer	58		
Speed selector lever lock			
control lamp	74		
Start-Stop			
Activating and deactivating	152		
Function	150		
Starting petrol engines	147, 148		
Starting the engine	147, 148		
After the fuel tank has been run dry	148		
Steam jets	183		
Steering	144		
Steering lock	145		
Steering column controls			
Audio Control	78		
Steering wheel height adjustment	144		
Storage compartment	132		
Front passenger side	122		
front seat	123		
Sun visor			
Sliding/tilting sunroof	98		
Sun visors	108		
Switch			
Hazard warning lights	105		
Heated rear window	104		
Light switch	100		
Switches			
Electric windows	95		
panoramic/tilting sunroof	98		
Switching off the engine	148		
T			
Tank			
Fuel level	59		
Reserve indicator	59		
Tank capacity	59		
Technical modifications	190		
The danger of not using the seat belt	22		
Tightening torque of wheel bolts	258		
Tilting sunroof	98		
Tools	223		
Top Tether system	50		
Tow-starting	252		
Towing	252		
Towing a trailer	178, 257		
Towing bracket	179		
Towing bracket, fitting	192		
Towline anchorage	252		
Towline anchorages	253		
Tow starting			
Comments	252		
Traction control system			
control lamp	72		
Trailer turn signals			
control lamp	107		
Trailer weights	257		
Turn signals	106		
control lamp	76, 107		
Two-way radio	191		
Tyre-Mobility-System (Tyre repair kit)	229		
Tyre Mobility-System (Tyre repair kit)	224		
Tyre pressure	217		
Control lamp	73		
Tyre pressures	258		
Tyre repair kit	224, 229		
Tyres and wheels			
Dimensions	219		
Tyres tread depth	218		
Tyres useful life	218		
Tyres with directional tread pattern	217		

U

Underbody protection 186

V

Vehicle battery 214

Vehicle data 256

Vehicle identification data 256

Vehicle identification number 256

Vehicle interior heating or cooling system ... 138

Vehicle interior monitoring and tow-away protection system*

 Activation 91

Vehicle modifications 190

Vehicle paintwork

 Maintenance 184

 Products for vehicle maintenance 181

Vehicle tools

 Storage 223

Vehicle washing 182

Ventilation 135

Ventilation slits 17

W

Warning lamps 65

Warning messages

 Red 68

 Yellow 68

Warning symbols 68

Warning triangle 128

Washer fluid 209

Washing by hand 182

Washing the vehicle 182

Washing tunnel 182

Washing with high pressure cleaners 183

Water in the windscreen washer tank 209

Wear indicators 218

Wearing suitable shoes 16

Wheel bolts 226, 258

 Tightening torque 220

Wheel change 224

Wheels 216, 258

Why assume the correct sitting position? 30

Why should head restraints be correctly adjusted? 13

Why wear seat belts? 19, 21, 30

Windows 95

Windscreen defrosting 135

Windscreen washer fluid

 control lamp 71

Windscreen wiper blades

 Cleaning 185

Windscreen wipers 109

 Changing blades 210

 Changing the rear wiper blade 212

Winter driving

 Diesel engine 200

Winter tyres 221

Wooden trim cleaning 188

Working in the engine compartment 200

SEAT S.A. is permanently concerned about continuous development of its types and models. For this reason we ask you to understand, that at any given time, changes regarding shape, equipment and technique may take place on the car delivered. For this reason no right at all may derive based on the data, drawings and descriptions in this current handbook.

All texts, illustrations and standards in this handbook are based on the status of information at the time of printing. Except for error or omission, the information included in the current handbook is valid as of the date of closing print.

Re-printing, copying or translating, whether total or partial is not allowed unless SEAT allows it in written form.

SEAT reserves all rights in accordance with the "Copyright" Act.

All rights on changes are reserved.

 This paper has been manufactured using bleached non-chlorine cellulose.

© SEAT S.A. - Reprint: 15.07.12

Inglés 6J8012003CA (07.12) (GT9)



6J8012003CA

